

SONY®

Home Audio System

Operating Instructions

Getting Started

Disc/USB Playback

USB Transfer

Tuner

BLUETOOTH Connection

Sound Adjustment

Other Operations

Additional Information

WARNING

To reduce the risk of fire, do not cover the ventilation opening of the appliance with newspapers, tablecloths, curtains, etc. Do not expose the appliance to naked flame sources (for example, lighted candles).

To reduce the risk of fire or electric shock, do not expose this appliance to dripping or splashing, and do not place objects filled with liquids, such as vases, on the appliance.

As the main plug is used to disconnect the unit from the mains, connect the unit to an easily accessible AC outlet. Should you notice an abnormality in the unit, disconnect the main plug from the AC outlet immediately.

Do not install the appliance in a confined space, such as a bookcase or built-in cabinet.

Do not expose batteries or appliances with battery-installed to excessive heat, such as sunshine and fire.

The unit is not disconnected from the mains as long as it is connected to the AC outlet, even if the unit itself has been turned off.

Indoor use only.

For product with CE marking

The validity of the CE marking is restricted to only those countries where it is legally enforced, mainly in the countries EEA (European Economic Area).

CAUTION

The use of optical instruments with this product will increase eye hazard.

CLASS 1 LASER PRODUCT
LASER KLASSE 1
LUOKAN 1 LASERLAITE
KLASS 1 LASERAPPARAT

This appliance is classified as a CLASS 1 LASER product under IEC 60825-1:2007. This marking is located on the rear exterior of the unit.

For customers in Europe

Disposal of waste batteries and electrical and electronic equipment (applicable in the European Union and other countries with separate collection systems)



This symbol on the product, the battery or on the packaging indicates that the product and the battery shall not be treated as household waste. On certain batteries this symbol might be used in combination with a chemical symbol. The chemical symbol for lead (Pb) is added if the battery contains more than 0.004% lead. By ensuring that these products and batteries are disposed of correctly, you will help to prevent potentially negative consequences for the environment and human health which could be caused by inappropriate waste handling. The recycling of the materials will help to conserve natural resources. In case of products that for safety, performance or data integrity reasons require a permanent connection with an incorporated battery, this battery should be replaced by qualified service staff only. To ensure that the battery and the electrical and electronic equipment will be treated properly, hand over these products at end-of-life to the appropriate collection point for the

recycling of electrical and electronic equipment. For all other batteries, please view the section on how to remove the battery from the product safely. Hand the battery over to the appropriate collection point for the recycling of waste batteries. For more detailed information about recycling of this product or battery, please contact your local Civic Office, your household waste disposal service or the shop where you purchased the product or battery.

Notice for customers: the following information is only applicable to equipment sold in countries applying EU directives.

This product has been manufactured by or on behalf of Sony Corporation. EU Importer: Sony Europe Limited. Inquiries to the EU Importer or related to product compliance in Europe should be sent to the manufacturer's authorized representative, Sony Belgium, bijkantoor van Sony Europe Limited, Da Vincilaan 7-D1, 1935 Zaventem, Belgium.

MHC-M60D only:

Hereby, Sony Corporation declares that this equipment is in compliance with Directive 2014/53/EU.

The full text of the EU declaration of conformity is available at the following internet address:

<http://www.compliance.sony.de/>



This radio equipment is intended to be used with the approved version(s) of software that are indicated in the EU Declaration of Conformity. The software loaded on this radio equipment is verified to comply with the essential requirements of the Directive 2014/53/EU.

Software version: _____
DVD _____

You can check the software version by pressing OPTIONS, then select "SYSTEM" – "VERSION" using $\blacktriangle/\blacktriangledown$ and $\boxed{+}$.

This equipment has been tested and found to comply with the limits set out in the EMC regulation using a connection cable shorter than 3 meters.

This Home Audio System is designed to be used for the following purposes:

- Playing back music/video sources on discs or USB devices
- Transferring music to USB devices
- Listening to radio stations
- Listening to TV sound
- Playing back music sources on BLUETOOTH devices
- Enjoying social gatherings with the Wireless Party Chain function

For customers in Australia



Disposal of old electrical & electronic equipment (applicable in the European Union and other countries with separate collection systems)

For customers in the United Arab Emirates

**TRA
REGISTERED No:
ER58862/17
DEALER No:
DA69600/17**

License and Trademark Notice

- **DVD** is a trademark of DVD Format/ Logo Licensing Corporation.
- "DVD+RW", "DVD-RW", "DVD+R", "DVD-R", "DVD VIDEO", and the "CD" logos are trademarks.
- WALKMAN® and WALKMAN® logo are registered trademarks of Sony Corporation.
- MPEG Layer-3 audio coding technology and patents licensed from Fraunhofer IIS and Thomson.
- Windows Media is either a registered trademark or trademark of Microsoft Corporation in the United States and/or other countries.
- This product is protected by certain intellectual property rights of Microsoft Corporation. Use or distribution of such technology outside of this product is prohibited without a license from Microsoft or an authorized Microsoft subsidiary.
- This system incorporates Dolby* Digital.
 - * Manufactured under license from Dolby Laboratories. Dolby, Dolby Audio, and the double-D symbol are trademarks of Dolby Laboratories.
- This system incorporates High-Definition Multimedia Interface (HDMI™) technology. The terms HDMI and HDMI High-Definition Multimedia Interface, and the HDMI Logo are trademarks or registered trademarks of HDMI Licensing Administrator, Inc. in the United States and other countries.
- "BRAVIA" is a trademark of Sony Corporation.
- LDAC™ and LDAC logo are trademarks of Sony Corporation.
- The BLUETOOTH® word mark and logos are registered trademarks owned by the Bluetooth SIG, Inc. and any use of such marks by Sony Corporation is under license. Other trademarks and trade names are those of their respective owners.
- Android is a trademark of Google LLC.
- Google Play is a trademark of Google LLC.
- Apple, the Apple logo, iPhone, and iPod touch are trademarks of Apple Inc., registered in the U.S. and other countries. App Store is a service mark of Apple Inc., registered in the U.S. and other countries.

- “Made for iPod,” and “Made for iPhone” mean that an electronic accessory has been designed to connect specifically to iPod or iPhone, respectively, and has been certified by the developer to meet Apple performance standards. Apple is not responsible for the operation of this device or its compliance with safety and regulatory standards. Please note that the use of this accessory with iPod or iPhone may affect wireless performance.

THIS PRODUCT IS LICENSED UNDER THE MPEG-4 VISUAL PATENT PORTFOLIO LICENSE FOR THE PERSONAL AND NON-COMMERCIAL USE OF A CONSUMER FOR

(i) ENCODING VIDEO IN COMPLIANCE WITH THE MPEG-4 VISUAL STANDARD (“MPEG-4 VIDEO”)

AND/OR

(ii) DECODING MPEG-4 VIDEO THAT WAS ENCODED BY A CONSUMER ENGAGED IN A PERSONAL AND NON-COMMERCIAL ACTIVITY AND/OR WAS OBTAINED FROM A VIDEO PROVIDER LICENSED TO PROVIDE MPEG-4 VIDEO.

NO LICENSE IS GRANTED OR SHALL BE IMPLIED FOR ANY OTHER USE. ADDITIONAL INFORMATION INCLUDING THAT RELATING TO PROMOTIONAL, INTERNAL AND COMMERCIAL USES AND LICENSING MAY BE OBTAINED FROM MPEG LA, L.L.C.

[HTTP://WWW.MPEGLA.COM](http://www.mpegla.com)

- All other trademarks are trademarks of their respective owners.
- In this manual, ™ and ® marks are not specified.

About this manual

- The instructions in this manual are for models MHC-M80D, MHC-M60D, and MHC-M40D. In this manual, the MHC-M80D is used for illustration purpose unless stated otherwise.
- This manual mainly explains operations using the remote control, but the same operations can also be performed using the buttons on the unit having the same or similar names.
- Icons, such as , listed at the top of each explanation indicate the type of media that can be used with the function being explained.
- Some illustrations are presented as conceptual drawings, and may be different from the actual products.
- The items displayed on the TV screen may vary depending on the area.
- The default setting is underlined.
- The text enclosed in bracket ([--]) appears on the TV screen, and the text enclosed in double quotation mark (“--”) appears on the display.

Table of Contents

About this manual	5
Unpacking	8
Playable discs or files on discs/USB device	8
Websites for compatible devices	11
Guide to parts and controls	12

Getting Started

Hooking up the system securely	17
Deactivating the demonstration	21
Inserting batteries	21
Positioning the speakers	21
Connecting the TV	22
Changing the color system	24
Performing the quick setup	24
Changing the display mode	25

Disc/USB Playback

Before using the USB device	25
Basic playback	25
Other playback operations	26
Using play mode	29

Restricting playback of the disc (Parental Control)	30
Viewing information of a disc and USB device	31
Using the Setup Menu	32

USB Transfer

Before using the USB device	36
Transferring music	36

Tuner

Listening to the radio	39
------------------------------	----

BLUETOOTH Connection

About the BLUETOOTH wireless technology	40
Pairing this system with a BLUETOOTH device	41
Listening to music on a BLUETOOTH device	42
Connecting this system with multiple BLUETOOTH devices (Multi-device connection) ...	42
Setting the BLUETOOTH audio codecs	43
Setting the BLUETOOTH standby mode	44
Turning on or off the BLUETOOTH signal	44
Controlling the system using a smartphone or tablet (Sony Music Center)	45

Getting frenzied parties with the “Fiestable” app.....	46
Achieving and sharing a Party People ranking and getting bonus features with Party King	46

Sound Adjustment

Adjusting the sound	47
Adjusting the subwoofer level (MHC-M80D only).....	47
Selecting the Virtual Football mode.....	47
Creating your own sound effect	48
Creating a party atmosphere (DJ Effect)	48

Other Operations

Using the Control for HDMI function.....	49
Enjoying wireless playback using multiple systems (Wireless Party Chain function)	51
Singing along: Karaoke.....	53
Using the Voice Guidance....	54
Enjoying sound from a guitar.....	54
Enjoying music with the Party Light and Speaker Light (MHC-M80D/ MHC-M60D only)	55
Using the Sleep Timer.....	56
Using optional equipment... ..	56
Deactivating the buttons on the unit (Child Lock)	56

Setting the automatic standby function.....	56
Updating the software.....	57

Additional Information

Troubleshooting	57
Precautions.....	67
Specifications.....	69
Language code list	72

Unpacking

- Remote control (1)
- RO3 (size AAA) batteries (2)
- FM lead antenna (1)
- AC power cord (mains lead) (1)
- AC plug adaptor* (1) (supplied only for certain areas)

* This plug adaptor is not for the use in Chile, Paraguay and Uruguay. Use this plug adaptor in the countries where it is necessary.

MHC-M80D only

- Unit: HCD-M80D (1)
- Speaker system: SS-M80D (2)
- Subwoofer: SS-WM80D (1)

MHC-M60D only

- Unit: HCD-M60D (1)
- Speaker system: SS-M60D (2)

MHC-M40D only

- Unit: HCD-M40D (1)
- Speaker system: SS-M40D (2)

Note

When unpacking or handling a big and/or heavy speaker, be sure to handle the speaker with two or more persons. Dropping the speaker may cause personal injury and/or property damage.

IMPORTANT NOTICE

Caution: This product is not portable and is not specifically designed to be easily carried. It must be securely placed on a cabinet.

Playable discs or files on discs/USB device

Playable discs

- DVD VIDEO

- DVD-R/DVD-RW in DVD VIDEO format or video mode
- DVD+R/DVD+RW in DVD VIDEO format
- VIDEO CD (Ver. 1.0, 1.1, and 2.0 discs)
- Super VCD
- CD-R/CD-RW/CD-ROM in VIDEO CD format or super VCD format
- AUDIO CD
- CD-R/CD-RW in AUDIO CD format

Playable files on discs

- Music:
MP3 files (.mp3)*1*2
- Video:
MPEG4 files (.mp4/.m4v)*2*3, Xvid files (.avi)

Playable files on USB device

- Music:
MP3 files (.mp3)*1*2, WMA files (.wma)*2, AAC files (.m4a/.mp4/.3gp)*2, WAV files (.wav)*2
- Video:
MPEG4 files (.mp4/.m4v)*2*3, Xvid files (.avi)

Note

- The discs must be in the following format:
 - CD-ROM/-R/-RW in DATA CD format that contains the MP3*1*2, MPEG4*2*3 and Xvid files, and conforms to ISO 9660*4 Level 1/Level 2 or Joliet (extended format).
 - DVD-ROM/-R/-RW/+R/+RW in DATA DVD format that contains the MP3*1*2, MPEG4*2*3 and Xvid files, and conforms to UDF (Universal Disk Format).
- The system will attempt to play back any data with the extensions above, even if it is not in the supported format. Playing this data may generate a loud noise which could damage your speaker system.

- *1 MP3 (MPEG 1 Audio Layer 3) is a standard format defined by ISO/ MPEG for compressed audio data. MP3 files must be in MPEG 1 Audio Layer 3 format.
- *2 Files with copyright protection (Digital Rights Management) cannot be played back by the system.
- *3 MPEG4 files must be recorded in MP4 file format. Supported video codec and audio codec are as follows:
 - Video codec: MPEG4 Simple Profile (AVC is not supported.)
 - Audio codec: AAC-LC (HE-AAC is not supported.)
- *4 A logical format of files and folders on CD-ROMs, defined by ISO (International Organization for Standardization).

Discs/files that cannot be played back

- You cannot play back the following discs
 - BDs (Blu-ray Discs)
 - CD-ROMs recorded in PHOTO CD format
 - Data part of CD-Extra or Mixed Mode CDs*
 - CD Graphics disc
 - Super Audio CDs
 - DVD Audio
 - DATA CD/DATA DVD that is created in Packet Write format
 - DVD-RAM
 - DATA CD/DATA DVD which has not been correctly finalized
 - CPRM (Content Protection for Recordable Media) compatible DVD-R/-RW recorded in Copy-Once programs
 - A disc that has a non-standard shape (e.g., heart, square, star)
 - A disc that has adhesive tape, paper, or a sticker attached to it
- You cannot play back the following files

- The video files which is larger than 720 (width) × 576 (height) pixels.
- The video files with a high width to length ratio.
- A WMA file in WMA DRM, WMA Lossless, or WMA PRO format.
- An AAC file in AAC DRM or AAC Lossless format.
- The AAC files which is encoded at 96 kHz.
- Files that are encrypted or protected by passwords.
- Files with DRM (Digital Rights Management) copyright protection.
- Some Xvid files that are longer than 2 hours.

- The MP3 PRO audio file can be played back as MP3 file.
- The system may not play back an Xvid file when the file has been combined from two or more Xvid files.
- * Mixed Mode CD: This format records data on the first track and audio (AUDIO CD data) on the second and subsequent tracks of a session.

Notes on CD-R/-RW and DVD-R/-RW/+R/+RW

- In some cases, a CD-R/-RW and DVD-R/-RW/+R/+RW cannot be played back on this system due to the recording quality or physical condition of the disc, or the characteristics of the recording device and authoring software. For more information, refer to the operating instructions of the recording device.
- Some playback functions may not work with some DVD+Rs/+RWs, even if they have been correctly finalized. In this case, view the disc by normal playback.

Notes on discs

- This product is designed to play back discs that conform to the Compact Disc (CD) standard.
- DualDisc and some music discs encoded with copyright protection technologies do not conform to the CD standard. Therefore, these discs may not be compatible with this product.

Note on multisession disc

This system can play back continuous sessions on a disc when they are recorded in the same format as the first session. However, the playback is not guaranteed.

Note on DVD VIDEO and VIDEO CD playback operations

Some playback operations for a DVD VIDEO or VIDEO CD may be intentionally restricted by software producers. Therefore, some playback features may not be available. Be sure to read the operating instructions of the DVD VIDEO or VIDEO CD.

Notes on playable files

- Playback may take a longer time to start when:
 - a DATA CD/DATA DVD/USB device is recorded with a complicated tree structure.
 - the audio files or video files in another folder have just been played back.
- The system can play back a DATA CD/DATA DVD or a USB device in the following conditions:
 - up to a depth of 8 folders
 - up to 300 folders
 - up to 999 files in a disc
 - up to 2,000 files in a USB device

— up to 650 files in a folder
These numbers may vary depending on the file or folder configuration.

- Folders that have no audio files or video files are skipped.
- Files transferred by a device such as a computer may not be played back in the order in which they were transferred.
- The playback order may not be applicable depending on the software used for creating the audio file or video file.
- Compatibility with all encoding/writing software of the supported formats, recording devices, and recording media cannot be guaranteed.
- Depending on the Xvid file, the picture may be unclear or the sound may skip.

Notes about USB devices

- This system is not guaranteed to operate with all USB devices.
- Although there are a variety of complex functions for USB devices, the playable contents of USB devices connected to the system are music and video contents only. For details, refer to the operating instructions of the USB device.
- When a USB device is inserted, the system reads all the files on the USB device. If there are many folders or files on the USB device, it may take a long time to finish reading the USB device.
- Do not connect the system and the USB device through a USB hub.
- With some connected USB devices, there may be a delay before an operation is performed by this system.

- The playback order for the system may differ from the playback order of the connected USB device.
- Before using a USB device, make sure that no virus-ridden files are on the USB device.

Websites for compatible devices

Check the websites below for the latest information about compatible USB and BLUETOOTH devices.

For customers in Latin America:

<<http://esupport.sony.com/LA>>

For customers in Europe and Russia:

<<http://www.sony.eu/support>>

For customers in other countries/regions:

<<http://www.sony-asia.com/support>>

Compatible iPhone/iPod models

The compatible iPhone/iPod models are as follows. Update your iPhone/iPod with the latest software before using with the system.

BLUETOOTH technology works with:

- iPhone 8 Plus
- iPhone 8
- iPhone 7 Plus
- iPhone 7
- iPhone SE
- iPhone 6s Plus
- iPhone 6s
- iPhone 6 Plus
- iPhone 6
- iPhone 5s
- iPhone 5c
- iPhone 5
- iPhone 4s
- iPod touch (6th generation)
- iPod touch (5th generation)

Guide to parts and controls

You can lock the keys except  (power) on the unit to prevent them from being operated by mistake (page 56).

Unit (Front)

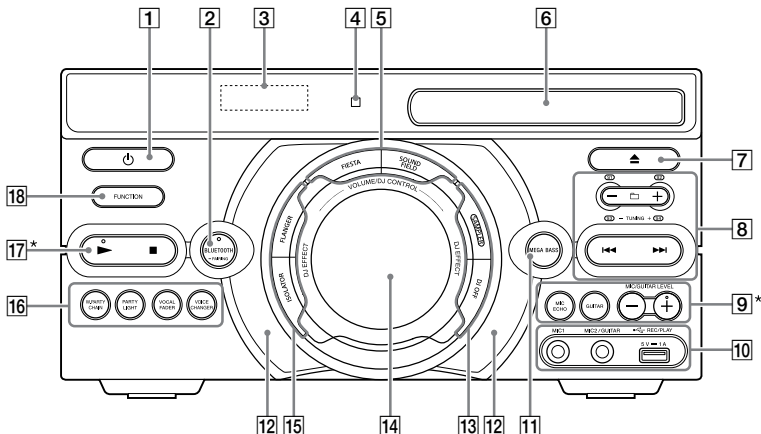

* The  and MIC/GUITAR LEVEL + buttons have a tactile dot. Use the tactile dot as a reference when operating the system.

1 (power)

Turns on the system, or sets it to standby mode.

2 BLUETOOTH

Selects BLUETOOTH function.

BLUETOOTH indicator (page 40)

- PAIRING

Hold down to activate BLUETOOTH pairing during BLUETOOTH function.

3 Display

4 Remote control sensor (page 21)

5 FIESTA (page 47)

SOUND FIELD (page 47)

6 Disc tray

7 (open/close)

Opens or closes the disc tray.

8 +/- (select folder)

Selects a folder on a data disc or a USB device.

◀◀/▶▶ (go backward/go forward) (page 26)

TUNING+/- (page 39)

S1, S2, S3, S4 (page 48)

- 9 MIC ECHO (page 53)**
GUITAR (page 55)
MIC/GUITAR LEVEL +/- (page 54)
- 10 MIC1 jack**
Use to connect the microphone.
MIC2/GUITAR jack
Use to connect the microphone or guitar.
↔ (USB) (REC/PLAY) port
Use to connect a USB device.
This port can be used for both playback and music transfer.
- 11 MEGA BASS (page 47)**
- 12 Front panel lighting**
(MHC-M80D/MHC-M60D only)
If the front panel lighting is glaring, do not look directly at it.
- 13 SAMPLER (page 48)**
DJ OFF (page 49)
- 14 VOLUME/DJ CONTROL knob**
Adjusts the volume.*
Adjusts the FLANGER and ISOLATOR effect or outputs the SAMPLER sound effect continuously (page 48).
* You cannot use this knob to adjust the volume when DJ Effect is selected.
- 15 FLANGER (page 48)**
ISOLATOR (page 48)
- 16 W.PARTY CHAIN (Wireless Party Chain) (page 51)**
PARTY LIGHT (page 25, 55)
(MHC-M80D only)
SPEAKER LIGHT (page 55)
(MHC-M60D only)
FOOTBALL (page 47)
(MHC-M40D only)
VOCAL FADER (page 53)
VOICE CHANGER (page 54)
- 17 ■ (stop)**
– Stops playback.
When pressed twice, resume playback can be canceled.
– Stops transfer during music transfer.
– Stops the built-in sound demonstration.
- ▶ (play)**
Starts playback.
Hold down ▶ for more than 2 seconds, the built-in sound demonstration will be played back. To stop the demonstration, press ■.
- 18 FUNCTION**
Selects a function.

Speaker (Rear)

MHC-M80D only

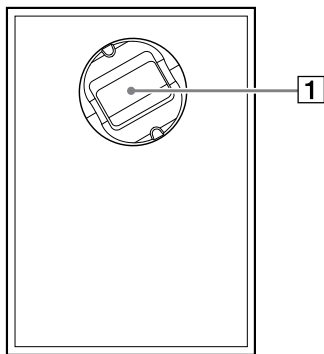

1 Party Light

Do not look directly at the light emitting part when the Party Light is turned on.

Remote control

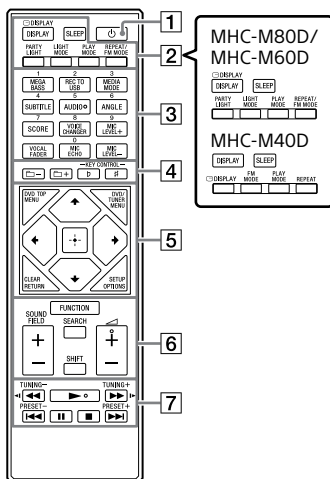

1 (power)

Turns on the system, or sets it to standby mode.

2 DISPLAY (page 21, 25, 32, 39, 41)

Changes the information on the display.

SLEEP (page 56)

PLAY MODE (page 29, 37)

MHC-M80D/MHC-M60D only:

DISPLAY*1 (page 31)

Views or hides the on-screen display.

PARTY LIGHT (page 25, 55)

LIGHT MODE (page 55)

REPEAT/FM MODE (page 30, 39)

MHC-M40D only:

 DISPLAY (page 31)

Views or hides the on-screen display.

FM MODE (page 39)

REPEAT (page 30)

- 3** Numeric (0 – 9) buttons*1*2
- Selects a track, chapter or file with its item number.
 - Enters numbers or values.

MEGA BASS (page 47)

REC TO USB

Transfers music to the USB device connected to the  (USB) port.

MEDIA MODE (page 26)

Selects the media to be played back on a data disc or USB device.

SUBTITLE (page 28)

AUDIO*2 (page 28, 32)

ANGLE (page 28)

SCORE (page 53)

VOICE CHANGER (page 54)

MIC LEVEL +/- (page 53)

VOCAL FADER (page 53)

MIC ECHO (page 53)

- 4**  +/- (select folder)
- Selects a folder on a data disc or a USB device.

KEY CONTROL b/# (page 53)

- 5** DVD TOP MENU
- Displays the DVD title on the TV screen.

DVD/TUNER MENU (page 26, 27, 40)

RETURN (page 26)

OPTIONS

Enters or exits the options menu.



Selects the menu items.

 (enter)

Enters/confirms the settings.

CLEAR (page 27)*1

SETUP (page 32)*1

- 6** FUNCTION
- Selects a function.

SEARCH (page 26, 27)

SHIFT*1

Hold down to activate the buttons printed in pink.

SOUND FIELD +/- (page 47)

 (volume) +/-*2

Adjusts the volume.

- 7**  (fast reverse/fast forward) (page 27)

 (slow back/slow forward) (page 27)

TUNING +/- (page 39)

▶ (play)*2

Starts playback.

◀◀/▶▶ (go backward/go forward) (page 26)

PRESET+/- (page 40)

|| (pause)

Pauses playback. To resume playback, press ▶.

■ (stop)

- Stops playback.
When pressed twice, resume playback can be canceled.
- Stops transfer during music transfer.
- Stops the built-in sound demonstration.

*1 This button is printed in pink. To use this button, hold down SHIFT (**6**) and press this button.

*2 The numeric button 5/AUDIO, ◀+ and ▶ buttons have a tactile dot. Use the tactile dot as a reference when operating the system.

Hooking up the system securely

Unit (Rear)

MHC-M80D

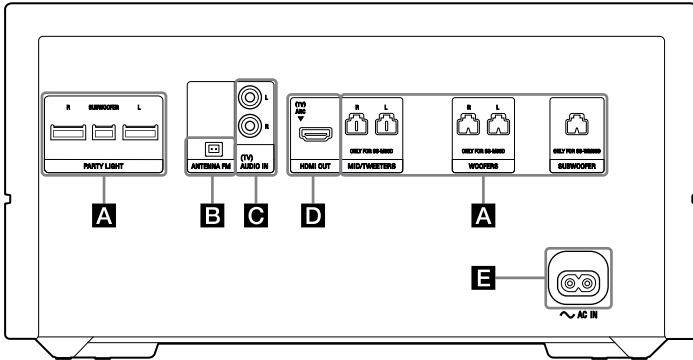

MHC-M60D

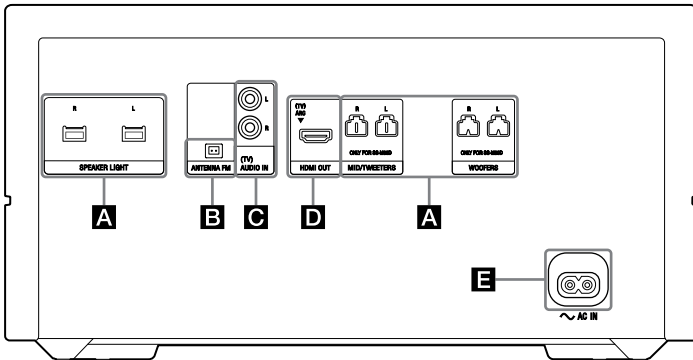

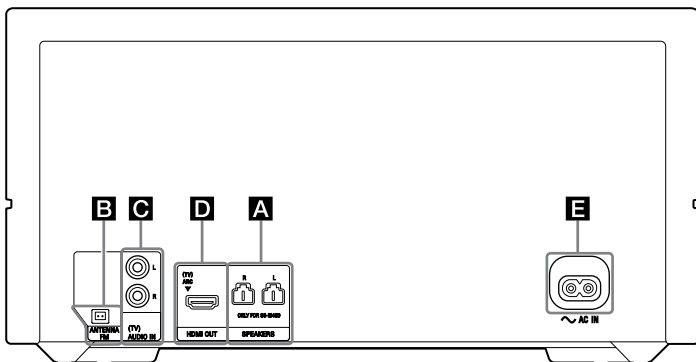

A Speakers

(MHC-M80D only)

- **PARTY LIGHT SUBWOOFER/L/R terminals**
Connect the Party Light connector of the speaker to this terminal. The lighting on the speakers will react according to the music source. You can select the Party Light according to your preference (page 55).
- **MID/TWEETERS L/R terminals**
Connect the speaker connector of the speaker to this terminal.
- **WOOFERS L/R terminals**
Connect the speaker connector of the speaker to this terminal.
- **SUBWOOFER**
Connect the speaker connector of the subwoofer to this terminal.

(MHC-M60D only)

- **SPEAKER LIGHT L/R terminals**
Connect the Speaker Light connector of the speaker to this terminal. You can also select the Speaker Light according to your preference (page 55).
- **MID/TWEETERS L/R terminals**
Connect the speaker connector of the speaker to this terminal.
- **WOOFERS L/R terminals**
Connect the speaker connector of the speaker to this terminal.

(MHC-M40D only)

- **SPEAKERS L/R terminals**
Connect the speaker connector of the speaker to this terminal.

Example:

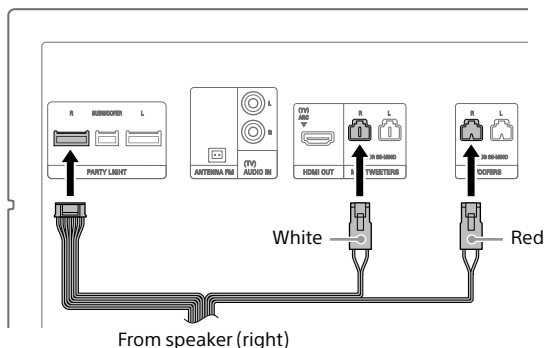

Note

- Be sure to use only the supplied speakers.
- When connecting speaker cables, insert the connector straight into the terminals.

B FM ANTENNA terminal

Find a location and an orientation that provide good reception when you set up the antenna.

Keep the antenna away from the speaker cables, the AC power cord (mains lead) and the USB cable to avoid picking up noise.

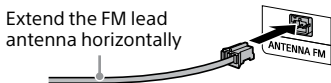

C AUDIO IN (TV) L/R jacks

Use an audio cable (not supplied) to connect to the audio output jacks of a TV or an audio/video equipment. The sound is output through this system.

D HDMI OUT (TV) ARC jack

Use an HDMI cable (not supplied) to connect to the HDMI input jack of a TV (page 22).

E AC power cord (mains lead)

Connect the AC power cord (mains lead) (supplied) to the unit, then plug it into a wall outlet.

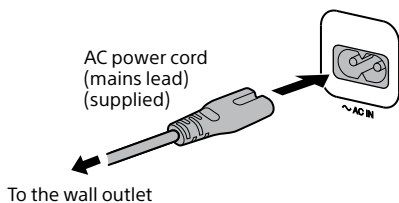

When the AC power cord (mains lead) is connected, the demonstration (page 25) starts automatically. If you press  (power) to turn on the system, the demonstration ends.

Deactivating the demonstration

To deactivate the demonstration while the system is turned off, press DISPLAY repeatedly to select the no display mode (Power Saving Mode) (page 25).

Inserting batteries

Insert the two supplied R03 (size AAA) batteries, matching the polarities shown below.

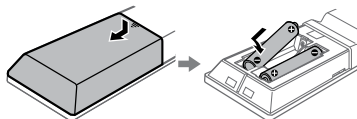

Note

- Do not mix an old battery with a new one or mix different types of batteries.
- If you do not use the remote control for a long period of time, remove the batteries to avoid damage from battery leakage and corrosion.

To operate the system using the remote control

Point the remote control at the unit's remote control sensor.

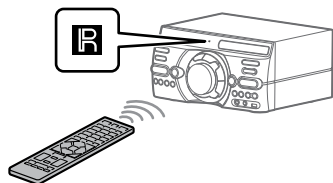

Positioning the speakers

To obtain optimum performance from the system, we recommend you to place the speakers as shown below.

- (A) Unit
- (B) Speaker (left)
- (C) Speaker (right)
- (D) Subwoofer (MHC-M80D only)
- (E) TV

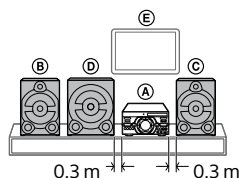

Note

(MHC-M80D only)

To obtain optimum Party Light effects, we recommend you to place the speakers from the wall as shown below.

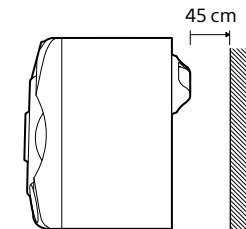

Connecting the TV

Before connecting cables, be sure to disconnect the AC power cord (mains lead).

To watch video

Connect the HDMI cable (not supplied) to the system.

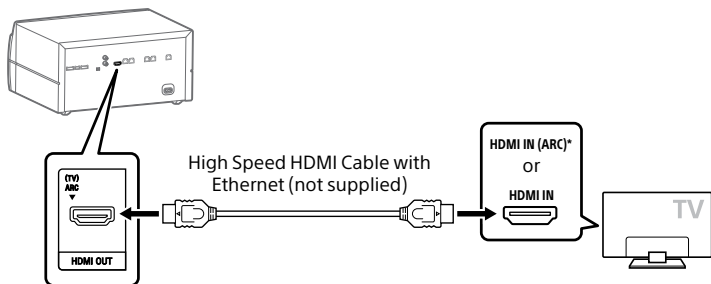

- * You can listen to TV sound via the system if you connect the system to the TV's HDMI IN (ARC) jack. The Audio Return Channel (ARC) function enables the TV to output sound through the system with an HDMI connection, without performing an audio connection (connection **A** below). To set the ARC function on this system, see [AUDIO RETURN CHANNEL] (page 36). To check the compatibility of your TV's ARC function, refer to the operating instructions supplied with your TV.

To listen to TV sound via the system

Choose one of the connections below (**A** or **B**).

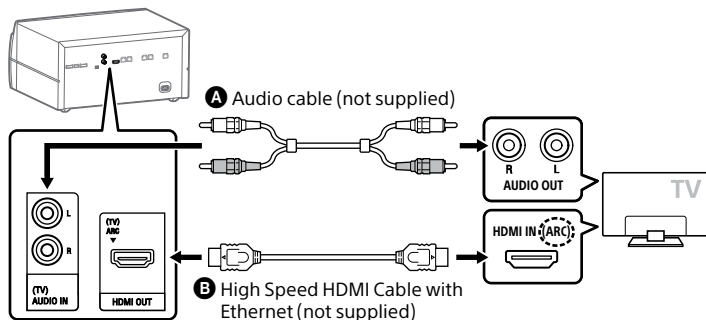

To listen to TV sound, press FUNCTION repeatedly to select "TV".

Hint

- You can also enjoy the sound of external equipment (DVD players, etc.) via the system by connecting to the AUDIO IN (TV) L/R jack as connection **A** above. For details, refer to the operating instructions of your equipment.
- If the audio output level from the system is low when connecting the external equipment, try adjusting the audio output settings on the connected equipment. It may improve the audio output level. For details, refer to the operating instructions of your equipment.

If "CODE 01" and "SGNL ERR" appear on the display of the unit

When the audio input signals to the system are other than 2-channel Linear PCM signals, the messages "CODE 01" and "SGNL ERR" (indicate that the input audio signals are unsupported) appear on the display of the unit. In this case, select the proper audio output mode on the TV in order to output 2-channel Linear PCM audio signals. For details, refer to the operating instructions of your TV.

Changing the color system

(Except for Latin American, European, and Russian models)

Set the color system to PAL or NTSC depending on the color system of your TV.

Each time you perform the procedure below, the color system changes as follows:
NTSC ↔ PAL

Use the buttons on the unit to perform this operation.

- 1 Press **⏻** to turn on the system.
- 2 Press **FUNCTION** repeatedly to select "DVD/CD".
- 3 Hold down **VOCAL FADER** and **SOUND FIELD** for more than 3 seconds.
"NTSC" or "PAL" appears on the display.

Performing the quick setup

Before using the system, you can make the minimum basic adjustments in the quick setup.

- 1 Turn on your TV and select the input according to the connection.
- 2 Press **⏻** to turn on the system.

- 3 Press **FUNCTION** repeatedly to select "DVD/CD".

The guide message [Press ENTER to run QUICK SETUP.] appears at the bottom of the TV screen.

- 4 Press **[+]** without loading a disc. [LANGUAGE SETUP] appears on the TV screen. Displayed items may vary depending on country or region.

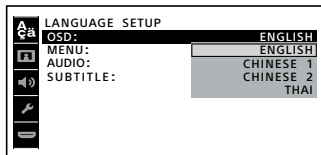

- 5 Press **↔** repeatedly to select a language, then press **[+]**. [VIDEO SETUP] appears on the TV screen.
- 6 Press **↔** repeatedly to select the setting that matches your TV type, then press **[+]**.
After [QUICK SETUP is complete.] appears on the TV screen, the system is ready for playback.

To change the setting manually
See "Using the Setup Menu" (page 32).

To quit the quick setup
Hold down **SHIFT** and press **SETUP**.

Note

The guide message appears when you turn on the system for the first time or after performing [RESET] (see "Returning the setup menu settings to the default" on page 65).

Changing the display mode

Press **DISPLAY** repeatedly while the system is turned off.

Each time you press the button, the display mode changes as follows.

Demonstration

The messages about the main features of this system scrolls across the display.

(MHC-M80D/MHC-M60D only)

The illumination will also turn on during demonstration.

To turn off the illumination, press **PARTY LIGHT**.

No display (Power Saving Mode)

The display is turned off to conserve power.

(MHC-M80D/MHC-M60D only)

The illumination is also turned off.

Disc/USB Playback

Before using the USB device

For compatible USB devices, see "Websites for compatible devices" (page 11).

(You can use your iPhone/iPod with this system via **BLUETOOTH** connection only.)

Basic playback

DVD-V **VIDEO CD** **CD** **DATA CD** **DATA DVD** **USB**

- 1 Press **FUNCTION** repeatedly to select "DVD/CD" or "USB".
- 2 Prepare the playback source.

For DVD/CD function:

Press **▲** on the unit to open the disc tray and load a disc with the label facing up.

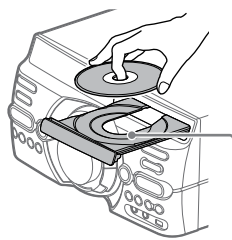

When you play back an 8 cm disc such as a CD single, place it on the inner circle of the tray.

Press **▲** on the unit again to close the disc tray.

Do not forcibly push the disc tray to close it as this may cause a malfunction.

For USB function:

Connect a USB device to the  (USB) port.









Note

You can use a USB adaptor (not supplied) to connect the USB device to the unit if the USB device cannot be plugged into the  (USB) port.

- 3**    only)
Press **MEDIA MODE** repeatedly to select the media type ([MUSIC]/[VIDEO]) you want.

- 4** Press  to start playback.

Other operations



To	Do this
Stop playback	Press  .
Pause playback	Press  .
Resume playback or return to normal playback	Press  .
Cancel the resume point	Press  twice.
Select a track, file, chapter or scene	Press   or  during playback. Or, hold down SHIFT and press the numeric buttons, then press  . (Operation might be prohibited by disc or USB device.)

To play from a specific file

- 1** Press **MEDIA MODE** repeatedly to select [MUSIC] or [VIDEO].

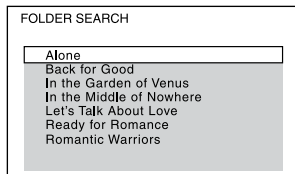

- 2** Press **SEARCH** to display the folder list.



- 3** Press / repeatedly to select the folder you want.

- 4** Press  to display the file list.



- 5** Press / repeatedly to select the file you want, then press .

Other playback operations

Depending on the type of disc or file, the function may not work.

To	Do this
View DVD menu	Press DVD/TUNER MENU.
View folder list or file list	Press SEARCH . Press SEARCH again to turn off the folder list or file list.
Return to folder list when in file list	Press RETURN .

To	Do this
Locate a point quickly in fast forward or fast reverse (Lock Search)	Press ◀◀ or ▶▶ during playback. Each time you press ◀◀ or ▶▶, the playback speed changes.
Watch frame by frame (Slow-motion Play)	Press II, then press ◀◀ or ▶▶. Each time you press ◀◀ or ▶▶, the playback speed changes.

Searching a specific track

CD

Hold down **SHIFT** and press the numeric buttons to select the track you want to play back, then press **[+]**.

To search using the **SEARCH** button

- 1 Press **SEARCH** to display the track list.
- 2 Press **↑/↓** repeatedly to select the track you want to play back, then press **[+]**.

Searching a specific title/ chapter/scene/track/index

DVD-V VIDEO CD

- 1 Press **SEARCH** repeatedly during playback to select the search mode.

- 2 Hold down **SHIFT** and press the numeric buttons to enter the title, chapter, scene, track, or index number you want, then press **[+]**.

Playback starts.

Note

- For VIDEO CD with PBC playback, press **SEARCH** to search the scene.
- For VIDEO CD without PBC playback, press **SEARCH** to search the track and index.

To search for a particular point using the time code

DVD-V

- 1 Press **SEARCH** repeatedly during playback to select the time search mode.
- 2 Hold down **SHIFT** and press the numeric buttons to enter the time code, then press **[+]**.

Example: To find a scene at 2 hours, 10 minutes, and 20 seconds, hold down **SHIFT** and press 2, 1, 0, 2, 0 ([2:10:20]).

If you make a mistake, hold down **SHIFT** and press **CLEAR** to cancel the number.

To search using the DVD menu

DVD-V

- 1 Press **DVD/TUNER MENU**.
- 2 Press **↑/↓/←/→**, or hold down **SHIFT** and press the numeric buttons, to select the title or item you want to play back, then press **[+]**.

Changing the camera angles

DVD-V

Press **ANGLE** repeatedly during playback to select the camera angle you want.

Selecting the subtitle setting

DVD-V

Press **SUBTITLE** repeatedly during playback to select the subtitle language you want or turn off the subtitle.

Changing the language/sound

DVD-V

VIDEO CD

C D

DATA CD

DATA DVD

USB

Press **AUDIO** repeatedly during playback to select the audio format or mode you want.

DVD VIDEO

You can select audio format or language when the source contains multiple audio formats or multilingual audio.

When 4 digits are displayed, they indicate a language code. See "Language code list" (page 72) to confirm which language the code represents. When the same language is displayed two or more times, the DVD VIDEO is recorded in multiple audio formats.

VIDEO CD/AUDIO CD/audio file

You can change the sound output.

- **[STEREO]**: The stereo sound.
- **[1/L]/[2/R]**: The monaural sound of the left or right channel.

SUPER VIDEO CD

- **[1:STEREO]**: The stereo sound of audio track 1.
- **[1:1/L]/[1:2/R]**: The monaural sound of the left or right channel of audio track 1.
- **[2:STEREO]**: The stereo sound of audio track 2.
- **[2:1/L]/[2:2/R]**: The monaural sound of the left or right channel of audio track 2.

Playing a VIDEO CD with PBC functions

VIDEO CD

You can use the PBC (Playback Control) menu to enjoy the interactive features of VIDEO CD (VIDEO CD Version 2.0 and Super VCD).

1 Press **▶** to play a VIDEO CD with PBC functions.

The PBC menu appears on the TV screen.

2 Hold down **SHIFT** and press the numeric buttons to select the item number you want, then press **[+]**.

3 Continue playback according to the instructions on the menu.

Note

PBC playback is canceled when Repeat Play is activated.

To cancel PBC playback

- 1 Press **◀◀** or **▶▶**, or hold down **SHIFT** and press the numeric buttons, to select a track when playback is stopped.
- 2 Press **▶** or **[+]**.
Playback starts from the selected track.

To return to PBC playback

Press **■** twice, then press **▶**.

Multi-disc resume play

DVD-V **VIDEO CD**

This system can store playback resume points for up to 6 discs and resumes playback when you insert the same disc again. If you store a playback resume point for the 7th disc, the resume point for the first disc will be deleted.

To activate this function, set **[MULTI-DISC RESUME]** in **[SYSTEM SETUP]** to **[ON]** (page 35).

Note

To play back from the beginning of the disc, press **■** twice, then press **▶**.

Using play mode

Playing in sequential order (Normal Play)

< D **DATA CD** **DATA DVD** **USB**

When playback is stopped, press **PLAY MODE** repeatedly.

■ When playing a disc

- **[DISC]**: plays the disc.
- **[FOLDER]***: plays all playable files in the specified folder on the disc.

* Cannot be selected for AUDIO CD.

■ When playing a USB device

- **[ONE USB DEVICE]**: plays the USB device.
- **[FOLDER]**: plays all playable files in the specified folder on the USB device.

Note

- "FLDR" and "SHUF" light off on the display when Normal Play is set to **[DISC]** or **[ONE USB DEVICE]**.
- "FLDR" lights up on the display when Normal Play is set to **[FOLDER]**.

Playing in random order (Shuffle Play)

< D **DATA CD** **DATA DVD** **USB**

When playback is stopped, press **PLAY MODE** repeatedly.

■ When playing a disc

- **[DISC (SHUFFLE)]**: shuffles all audio files on the disc.

- [FOLDER (SHUFFLE)]*: shuffles all audio files in the specified folder on the disc.

* Cannot be selected for AUDIO CD.

■ When playing a USB device

- [ONE USB DEVICE (SHUFFLE)]: shuffles all audio files on the USB device.
- [FOLDER (SHUFFLE)]: shuffles all audio files in the specified folder on the USB device.

Note

- “SHUF” lights up on the display when Shuffle Play is set to [DISC (SHUFFLE)] or [ONE USB DEVICE (SHUFFLE)].
- “FLDR” and “SHUF” light up on the display when Shuffle Play is set to [FOLDER (SHUFFLE)].
- Shuffle Play cannot be performed for video files.
- Shuffle Play is canceled when you:
 - open the disc tray.
 - perform Synchronized Transfer.
 - change Media Mode.
- Shuffle Play may be canceled when you select a folder or a track to play back.

Playing repeatedly (Repeat Play)

DVD-V VIDEO CD C D DATA CD DATA DVD USB

Press REPEAT repeatedly.

Depending on the type of disc or file, some settings may not be available.



- [OFF]: does not play back repeatedly.
- [ALL]: repeats all tracks or files in the selected play mode.
- [DISC]: repeats all contents (DVD VIDEO and VIDEO CD only).
- [TITLE]: repeats the current title (DVD VIDEO only).
- [CHAPTER]: repeats the current chapter (DVD VIDEO only).
- [TRACK]: repeats the current track.

- [FILE]: repeats the current video file.

To cancel Repeat Play

Press REPEAT repeatedly to select [OFF].







Note

- “” lights up on the display when Repeat Play is set to [ALL] or [DISC].
- “ 1” lights up on the display when Repeat Play is set to [TITLE], [CHAPTER], [TRACK] or [FILE].
- You cannot perform Repeat Play with VIDEO CD during PBC playback.
- Depending on the DVD VIDEO, you cannot perform Repeat Play.
- Repeat Play is canceled when you:
 - turn off the system (DVD VIDEO and VIDEO CD only).
 - open the disc tray.
 - change the function (DVD VIDEO and VIDEO CD only).
 - perform Synchronized Transfer.
 - change Media Mode.

Restricting playback of the disc (Parental Control)

DVD-V

You can restrict playback of DVD VIDEOS according to a predetermined level. Scenes may be skipped or replaced with different scenes.

- 1 When playback is stopped, hold down SHIFT and press SETUP.
- 2 Press / repeatedly to select [SYSTEM SETUP], then press .
- 3 Press / repeatedly to select [PARENTAL CONTROL], then press .

- 4 Hold down **SHIFT** and press the numeric buttons to enter or re-enter your 4-digit password, then press **[+]**.
- 5 Press **↕/↕** repeatedly to select **[STANDARD]**, then press **[+]**.
- 6 Press **↕/↕** repeatedly to select a geographic area as the playback limitation level, then press **[+]**.
The area is selected.
When you select **[OTHERS→]**, enter the area code for the geographic area you want according to the "Parental Control area code list" (page 73) by holding down **SHIFT** and press the numeric buttons.
- 7 Press **↕/↕** repeatedly to select **[LEVEL]**, then press **[+]**.
- 8 Press **↕/↕** repeatedly to select the level you want, then press **[+]**.
The lower the value, the stricter the limitation.

To turn off the parental control function

Set **[LEVEL]** to **[OFF]** in step 8.

To play back a disc for which the parental control is set

- 1 Load the disc and press **▶**.
The display for entering your password appears on the TV screen.
- 2 Hold down **SHIFT** and press the numeric buttons to enter or re-enter your 4-digit password, then press **[+]**.
The system starts playback.

If you forget your password

Remove the disc and repeat steps 1 to 3 of "Restricting playback of the disc (Parental Control)" (page 30). Hold down **SHIFT** and press the numeric buttons to enter a password "199703", then press **[+]**. Follow the on-screen instructions and enter a new 4-digit password. Then, reload the disc and press **▶**. You need to enter your new password again.

Viewing information of a disc and USB device

DVD-V VIDEO CD CD DATA CD DATA DVD USB

Information on the TV screen

(MHC-M80D/MHC-M60D only)

Hold down **SHIFT** and press **[DISPLAY]** repeatedly during playback.

(MHC-M40D only)

Press **[DISPLAY]** repeatedly during playback.

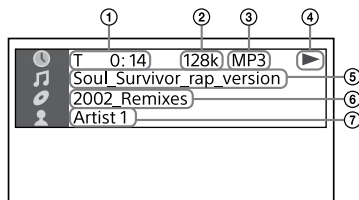

- ① **Playback information**
Playing time and remaining time
- ② **Bit rate**
- ③ **Media type**
- ④ **Playback status**
- ⑤ **Title*1/track/file name*2**

- ⑥ **Album**^{*1}/**folder name**^{*2}/**chapter/index number**
- ⑦ **Artist name**^{*1*2}
Appears when playing an audio file.

^{*1} If an audio file has an ID3 tag, the system will display an album name/ title name/artist name from the ID3 tag information. The system can support ID3 ver 1.0/1.1/2.2/2.3.

^{*2} If the name contains characters which cannot be displayed, those characters will be displayed as “_”.

Note

- Depending on the source being played,
 - some information may not be displayed.
 - some characters cannot be displayed.
- Depending on the play mode, the information displayed may be different.

Displaying the audio format information in DVD VIDEOS and video files

Press AUDIO during playback.

Information on the display

Press DISPLAY repeatedly when the system is turned on.

You can view the information as follows:

- playing time/remaining time of track, title, chapter
- scene number
- file name, folder name
- title, artist and album information

Note

- The disc name or track name may not be displayed depending on the characters.
- Playing time of audio files and video files may not be displayed correctly.

- The elapsed playing time for an audio file encoded using a VBR (variable bit rate) is not displayed correctly.

Using the Setup Menu

You can make various adjustments to items such as picture and sound. Displayed items vary depending on the country or region.

Note

Playback settings stored in the disc take priority over the setup menu settings. Therefore, some of the setup menu settings may not be performed.

1 When playback is stopped in DVD/CD or USB function, hold down SHIFT and press SETUP.

The setup menu appears on the TV screen.

2 Press \uparrow/\downarrow repeatedly to select [LANGUAGE SETUP], [VIDEO SETUP], [AUDIO SETUP], [SYSTEM SETUP] or [HDMI SETUP], then press \square .

3 Press \uparrow/\downarrow repeatedly to select the item you want, then press \square .

4 Press \uparrow/\downarrow repeatedly to select the setting you want, then press \square .

The setting is selected and setup is completed.

To exit the menu

Hold down SHIFT and press SETUP.



Setting the language – [LANGUAGE SETUP]

[OSD]

Sets the language of the on-screen display.

[MENU]

DVD-V

Sets the language for the DVD menu.

[AUDIO]

DVD-V

Switches the language of the sound track.

When you select [ORIGINAL], the language given priority in the disc is selected.

[SUBTITLE]

DVD-V

Switches the language of the subtitle recorded in the DVD VIDEO. When you select [AUDIO FOLLOW], the language for the subtitles changes according to the language you selected for the sound track.

Note

If you select [OTHERS→] in [MENU], [AUDIO], and [SUBTITLE], enter a language code from the "Language code list" (page 72) using the numeric buttons.



Setting the TV screen – [VIDEO SETUP]

[TV TYPE]

DVD-V

[16:9]: Selects this when you connect a wide-screen TV or a TV with a wide-mode function.



[4:3 LETTER BOX]: Selects this when you connect a 4:3 screen TV that does not have a wide-mode function. This setting displays a wide picture with black bands on the top and bottom.



[4:3 PAN SCAN]: Selects this when you connect a 4:3 screen TV that does not have a wide-mode function. This setting displays a full-height picture on the entire screen, with trimmed sides.



[4:3 OUTPUT]

DVD-V

[FULL]: Selects this when you connect a TV with a wide-mode function. Displays a 4:3 screen picture in 16:9 aspect ratio even on a wide-screen TV.

[NORMAL]: Changes the picture size to fit the screen size with the original picture aspect ratio. This setting displays black bands on the left and right side if you display a 4:3 screen picture.



[COLOR SYSTEM(VIDEO CD)]

(Except for Latin American, European, and Russian models)

VIDEO CD

Sets the color system (PAL or NTSC).

[AUTO]: Outputs the video signal according to the color system of the disc. Select this setting if your TV uses a DUAL system.

[PAL]: Changes the video signal of an NTSC disc and output it in PAL system.

[NTSC]: Changes the video signal of a PAL disc and output it in NTSC system.

For details, see "Changing the color system" (page 24).

[PAUSE MODE]

DVD-V

[AUTO]: The picture, including subjects that move dynamically, is output with no jitter. Normally select this setting.

[FRAME]: The picture, including subjects that do not move dynamically, is output in high resolution.

Setting the audio options - **[AUDIO SETUP]**

[AUDIO DRC]

(Dynamic Range Compression)

DVD-V

Useful for watching movies at low volume late at night.

[OFF]: Off.

[STANDARD]: The dynamic range is compressed as intended by the recording engineer.

[TRACK SELECTION]

DVD-V

Gives priority to the sound track which contains the highest number of channels when you play back a DVD VIDEO on which multiple audio formats (PCM, MPEG audio, or Dolby Digital) are recorded.

[OFF]: No priority given.

[AUTO]: Priority given.

[A/V SYNC]

DVD-V

VIDEO CD

DATA CD

DATA DVD

(Video files only)

[OFF]: Does not adjust.

[ON]: Adjusts the delay between picture and sound when the sound does not synchronize with the displayed picture.

[DOWNMIX]

DVD-V

Selects the audio output signal for playing a multi-channel audio.

[NORMAL]: Outputs multi-channel audio into a 2-channel stereo signal.

[DOLBY SURROUND]: Outputs multi-channel audio into a 2-channel surround signal.



Setting the system – [SYSTEM SETUP]

[SCREEN SAVER]

The screen saver will help prevent your display device from becoming damaged (ghosting). Press \triangleleft +/- to exit the screen saver.

[ON]: The screen saver image appears if you do not operate the system for about 15 minutes.

[OFF]: Turns off the function. The screen saver image does not appear.

[BACKGROUND]

Selects the background color or picture to be displayed on the TV screen.

[JACKET PICTURE]: The jacket picture (still picture) recorded on the disc appears in the background.

[GRAPHICS]: A preset picture stored in the system appears in the background.

[BLUE]: The background color is blue.

[BLACK]: The background color is black.

[PARENTAL CONTROL]

Sets the playback restrictions. For details, see "Restricting playback of the disc (Parental Control)" (page 30).

[MULTI-DISC RESUME]

DVD-V VIDEO CD

[ON]: Stores the resume playback point in the memory for up to 6 discs.

[OFF]: Playback starts at the resume playback point only for the current disc in the system.

[RESET]

Returns the setup menu settings to the default settings. For details, see "Returning the setup menu settings to the default" (page 65).



Setting the HDMI options – [HDMI SETUP]

[HDMI RESOLUTION]

Selects the TV output resolution when the TV is connected via HDMI cable.

[AUTO(1920×1080p)]: Outputs video signals according to the resolution of the TV.

**[1920×1080i]/[1280×720p]/
[720×480p]^{*1}/[720×480/576p]^{*2}:**
Outputs video signals according to the selected resolution setting.

^{*1} For Latin American models only.

^{*2} For other models.

[YCbCr/RGB(HDMI)]

[YCbCr]: Outputs YCbCr video signals.

[RGB]: Outputs RGB video signals.

[AUDIO(HDMI)]

[AUTO]: Outputs audio signals in original format from HDMI OUT (TV) ARC jack.

[PCM]: Outputs 2-channel Linear PCM signals from HDMI OUT (TV) ARC jack.

[CONTROL FOR HDMI]

[ON]: The Control for HDMI function is enabled. You can operate mutually between system and TV connected with an HDMI cable.

[OFF]: Off.

[AUDIO RETURN CHANNEL]

Set this function when the system is connected to a TV's HDMI IN jack that is compatible with Audio Return Channel. This function is available when you set [CONTROL FOR HDMI] to [ON].

[ON]: You can listen to TV sound from the speakers of the system.

[OFF]: Off.

[STANDBY LINKED TO TV]

This function is available when you set [CONTROL FOR HDMI] to [ON].

[AUTO]: When you turn off the TV, the system turns off automatically in the following conditions:

- while playing video in DVD/CD or USB function
- when the audio playback is stopped in DVD/CD or USB function
- when TV function is selected

[ON]: The system turns off automatically when you turn off the TV regardless of the function.

[OFF]: The system does not turn off when you turn off the TV.

USB Transfer

Before using the USB device

For compatible USB devices, see “Websites for compatible devices” (page 11).

(You can use your iPhone/iPod with this system via BLUETOOTH connection only.)

Transferring music

You can transfer music from a disc (AUDIO CD or MP3 disc only) to a USB device connected to the  (USB) port.

The audio format of files transferred by this system is MP3.

Note

- Do not remove the USB device during transfer or erase operations. Doing so may corrupt the data on the USB device or damage the USB device itself.
- MP3 files are transferred with the same bit rate as the original files.
- When transferring from AUDIO CD, you may select the bit rate before transferring.
- USB transfer and erase operations are prohibited when the disc tray is opened.

Note on copyright-protected content

The transferred music is limited to private use only. Use of the music beyond this limit requires permission of the copyright holders.

To select the bit rate

You can select a higher bit rate to transfer music with better quality.

- 1** Press **OPTIONS**.

- 2 Press **↑/↓** repeatedly to select "BIT RATE", then press **[+]**.
- 3 Press **↑/↓** repeatedly to select the bit rate you want, then press **[+]**.
 - "128 KBPS": encoded MP3 files have smaller file size and lower audio quality.
 - "256 KBPS": encoded MP3 files have bigger file size but higher audio quality.

To exit the options menu, press **OPTIONS**.

Transferring music from a disc

You can transfer music to a USB device connected to **↔** (USB) port as follows:

- Synchronized Transfer: Transfer all tracks or MP3 files from a disc to USB.
- REC1 Transfer: Transfer a single track or MP3 file during playback.

- 1 **Connect a transferable USB device to the **↔** (USB) port on the unit.**

Note

You can use a USB adaptor (not supplied) to connect the USB device to the unit if the USB device cannot be plugged into the **↔** (USB) port.

- 2 **Press **FUNCTION** repeatedly to select "DVD/CD", then load a disc.**

- 3 **Prepare the sound source.**

Synchronized Transfer:

If the system starts playback automatically, press **■** twice to stop the playback fully.

When playback is stopped, press **PLAY MODE** repeatedly to select the play mode you want.

Note

If you start transferring in Shuffle Play or Repeat Play, the selected play mode changes to Normal Play automatically.

REC1 Transfer:

Select the track or MP3 file you want to transfer, then start playback.

- 4 **Press **REC TO USB**.**

"PUSH ENTER" appears on the display.

- 5 **Press **[+]**.**

The transfer starts, then "DO NOT REMOVE" appears on the display. Do not remove the USB device until the transfer is complete.

When the transfer is complete, the system performs as follows:

Synchronized Transfer:

The disc stops automatically.

REC1 Transfer:

The disc continues to play the next track or file.

To stop transfer

Press **■**.

Notes on transfer

- You cannot transfer MP3 files on a UDF (Universal Disk Format) formatted disc to the USB device.
- While transferring, no sound is output.
- CD-TEXT information is not transferred to the created MP3 files.

- The transfer stops automatically if:
 - the USB device runs out of space during transfer.
 - the number of audio files or folders on the USB device reaches the limit that the system can recognize.
- If a folder or file that you are trying to transfer already exists on the USB device with the same name, a sequential number is added after the name without overwriting the original folder or file.
- You cannot perform the following operations during transfer:
 - Eject the disc.
 - Select another track or file.
 - Pause playback or find a point in the track or file.
 - Change the function.
- When transferring music to a WALKMAN® using “Media Manager for WALKMAN”, be sure to transfer in MP3 format.
- When connecting a WALKMAN® to the system, be sure to connect after the display “Creating Library” or “Creating Database” on the WALKMAN® has disappeared.

Folder and file generation rules

Maximum number of MP3 files that can be generated

- 298 folders
- 650 files in a folder
- 650 files in REC1-CD or REC1-MP3 folder.

These numbers may vary depending on the file or folder configuration.

When transferring to a USB device, a “MUSIC” folder is created directly below “ROOT”. Folders and files are generated within this “MUSIC” folder according to the transfer method and source as follows:

Synchronized Transfer

■ When transferring all tracks from an AUDIO CD

Folder name: “CDDA0001”
File name: “TRACK001”*

■ When transferring MP3 files from a disc

Folder name: Same as the source
File name: Same as the source

REC1 Transfer

■ When transferring a track from an AUDIO CD

Folder name: “REC1-CD”
File name: “TRACK001”*

■ When transferring an MP3 file from a disc

Folder name: “REC1-MP3”
File name: Same as the source

* Folder and file numbers are assigned serially thereafter.

Erasing audio files or folders on the USB device

- 1** Press **FUNCTION** repeatedly to select “USB”.
- 2** Press **MEDIA MODE** repeatedly to select **[MUSIC]**.
- 3** When playback is stopped, press **OPTIONS**.
- 4** Press **↕/↔** repeatedly to select “ERASE”, then press **[+]**.
The folder list is displayed on the TV screen.

- 5** Press **↑/↓** repeatedly to select a folder, then press **[+]**.

The file list is displayed on the TV screen.

- 6** Press **↑/↓** repeatedly to select an audio file you want to erase, then press **[+]**.

If you want to erase all the audio files in the folder, select [ALL TRACKS] on the list. "FOLDER ERASE" or "TRACK ERASE" and "PUSH ENTER" appear on the display.

To cancel erase operations, press **■**.

- 7** Press **[+]**.

"COMPLETE" appears on the display.

To exit the options menu, press **OPTIONS**.

Note

- You can erase the supported audio file, MP4 format file, and 3GP format file only.
- You cannot erase audio files or folders when Shuffle Play has been selected. Set the play mode to Normal Play before erasing.
- Erase operation is prohibited when the disc tray is opened.

Tuner

Listening to the radio

- 1** Press **FUNCTION** repeatedly to select "TUNER FM".

- 2** Tune to a station.

For automatic scanning:

Hold down **TUNING+/-** until the frequency begins to change on the display.

Scanning stops automatically when a station is tuned in. "ST" (for FM stereo programs only) lights up on the display.

If scanning does not stop, press **■** to stop scanning. Then, perform manual tuning (below).

For manual tuning:

Press **TUNING+/-** repeatedly to tune to the station you want.

Note

When you tune to an FM station that provides RDS services, information such as the service name or station name is provided by broadcasts. You can check the RDS information by pressing **DISPLAY** repeatedly.

Hint

To reduce static noise on a weak FM stereo station, press **FM MODE** repeatedly until "ST" disappears from the display. You will lose the stereo effect, but reception will improve.

Presetting radio stations

You can store up to 20 FM stations as your favorite stations.

- 1 Tune to the station you want.**
- 2 Press DVD/TUNER MENU.**
- 3 Press \uparrow/\downarrow repeatedly to select the preset number you want, then press $\boxed{+}$.**

“COMPLETE” appears on the display and the station is stored.

If another station is already assigned to the selected preset number, that station is replaced by the new one.

To listen to the preset station

Press PRESET+/- repeatedly to select the preset number you want. Alternatively, hold down SHIFT and press the numeric buttons, then press $\boxed{+}$.

BLUETOOTH Connection

About the BLUETOOTH wireless technology

BLUETOOTH wireless technology is a short-range wireless technology that enables wireless data communication between digital devices.

Supported BLUETOOTH version, profiles and codecs

For details, see “BLUETOOTH section” (page 70).

Compatible BLUETOOTH devices

For details, see “Websites for compatible devices” (page 11).

About the BLUETOOTH indicator

The BLUETOOTH indicator on the unit lights up or flashes in blue to show the BLUETOOTH status.

System status	Indicator status
BLUETOOTH standby	Flashes slowly
BLUETOOTH pairing	Flashes quickly
BLUETOOTH connection is established	Lights up

Pairing this system with a BLUETOOTH device

Pairing is an operation where BLUETOOTH devices register with each other beforehand. Once a pairing operation is performed, it does not need to be performed again.

- 1 Place the BLUETOOTH device within 1 meter from the unit.
- 2 Press FUNCTION repeatedly to select "BLUETOOTH".

Hint

- When there is no pairing information on the system (for example, when you use the BLUETOOTH function for the first time after purchase), "PAIRING" flashes on the display and the system enters the pairing mode. Proceed to step 4.
- If the system is connected to a BLUETOOTH device, press BLUETOOTH on the unit to disconnect the BLUETOOTH device.

- 3 Hold down – PAIRING on the unit for 2 seconds or more. "PAIRING" flashes on the display.
- 4 Turn on the BLUETOOTH function on the BLUETOOTH device and perform the pairing procedure.
For details, refer to the operating instructions of your BLUETOOTH device.

- 5 Select the system's name (for example, "MHC-M80D") on the display of the BLUETOOTH device.

Perform this step within 5 minutes, otherwise pairing will be canceled. In this case, repeat from step 3.

Note

If passkey is required on the BLUETOOTH device, enter "0000". "Passkey" may be called "Passcode", "PIN code", "PIN number", or "Password".

- 6 Establish connection with the BLUETOOTH device.

When pairing is completed and the BLUETOOTH connection is established, BLUETOOTH device name appears on the display.

Depending on the BLUETOOTH device, connection may start automatically after pairing is completed.

You can check the BLUETOOTH device address by pressing DISPLAY repeatedly.

Note

- You can pair up to 8 BLUETOOTH devices. If the 9th BLUETOOTH device is paired, the oldest paired device will be deleted.
- If you want to pair with another BLUETOOTH device, repeat steps 1 to 6.

To cancel the pairing operation

Hold down – PAIRING on the unit for 2 seconds or more until "BT AUDIO" appears on the display.

To erase pairing information

You can erase all pairing information by resetting the system. See "Resetting the system" (page 65).

Note

After you reset the system, it may not be able to connect with your iPhone/iPod touch. In this case, delete the pairing information of the system on your iPhone/iPod touch, and then perform the pairing procedure again.

Listening to music on a BLUETOOTH device

You can listen to music on the BLUETOOTH device and control the playback using the buttons on the unit or the remote control. Check the following before playing music:

- The BLUETOOTH function of the BLUETOOTH device is turned on.
- Pairing has been completed (page 41).

Once the system and the BLUETOOTH device are connected, you can control playback by pressing **▶**, **⏸**, **■**, **◀◀/▶▶** and **◀◀/▶▶**.

1 Press BLUETOOTH on the unit to select the BLUETOOTH function.

“BLUETOOTH” appears on the display.

2 Establish connection with the BLUETOOTH device.

Press BLUETOOTH on the unit to connect to the last connected BLUETOOTH device.

Perform the BLUETOOTH connection from the BLUETOOTH device if the device is not connected.

Once the connection is established, the BLUETOOTH device name appears on the display.

3 Press **▶** to start playback.

Depending on the BLUETOOTH device,

- you may need to press **▶** twice.
- you may need to start playing an audio source on the BLUETOOTH device.

4 Adjust the volume.

Adjust the volume of the BLUETOOTH device first. If the volume level is still too low, adjust the volume level on the system.

Note

When the system is not connected to any BLUETOOTH device, the system will connect to the last connected BLUETOOTH device automatically when you press BLUETOOTH or **▶** on the unit.

To terminate the BLUETOOTH connection

Press BLUETOOTH on the unit. “BT AUDIO” appears on the display. Depending on the BLUETOOTH device, the BLUETOOTH connection may be terminated automatically when you stop playback.

Connecting this system with multiple BLUETOOTH devices (Multi-device connection)

You can connect up to three BLUETOOTH devices to the system at the same time with A2DP/AVRCP connection.

Before pairing the next BLUETOOTH device, be sure that the BLUETOOTH function on the system is turned on and the first BLUETOOTH device is connected to the system.

To pair with the second or third device

Repeat steps 1 to 6 of “Pairing this system with a BLUETOOTH device” (page 41).

To switch the playback source

Start playback on another connected BLUETOOTH device while the current device is playing music. The system will output the sound from the latest device.

Note

- Operations may vary depending on the BLUETOOTH device. A BLUETOOTH device may not be connected depending on the combination of the devices. For details, refer to the operating instructions of the device.
- If you try to connect the 4th BLUETOOTH device, the oldest playback device will be disconnected.
- Depending on the BLUETOOTH device, you may not be able to make three BLUETOOTH connections at the same time.
- You cannot establish the multi-device connection when using the Wireless Party Chain function.

To disconnect any BLUETOOTH device from the multi-device connection

Terminate the BLUETOOTH connection from the BLUETOOTH device which you want to disconnect.

To disconnect all BLUETOOTH devices from the multi-device connection

Press BLUETOOTH on the unit.

Setting the BLUETOOTH audio codecs

You can enable AAC, LDAC or SBC codec reception from BLUETOOTH device. AAC/LDAC can be selected only when the BLUETOOTH device supports AAC/LDAC.

1 Press **OPTIONS**.

2 Press **↕/↕** repeatedly to select “**BT CODEC**”, then press **[+]**.

3 Press **↕/↕** repeatedly to select the setting, then press **[+]**.

- “**AUTO**”: Enable reception in AAC or LDAC codec format.
- “**SBC**”: Receive in SBC codec format.

To exit the options menu, press **OPTIONS**.

Note

- You can enjoy high quality sound if AAC or LDAC is selected. If you cannot listen to AAC or LDAC sound from your device or the sound is interrupted, select “**SBC**”.
- If you change this setting while the system is connected to a BLUETOOTH device, the BLUETOOTH device will be disconnected. To connect to the BLUETOOTH device, perform the BLUETOOTH connection again.

Hint

LDAC is an audio coding technology developed by Sony that enables the transmission of High-Resolution (Hi-Res) Audio content, even over a BLUETOOTH connection. Unlike other BLUETOOTH compatible coding technologies such as SBC, it operates without any down-conversion of the Hi-Res Audio content^{*1}, and allows approximately three times more data^{*2} than those other technologies to be transmitted over a BLUETOOTH wireless network with unprecedented sound quality, by means of efficient coding and optimized packetization.

^{*1} Excluding DSD format contents.

^{*2} In comparison with SBC (Subband Coding) when the bitrate of 990 kbps (96/48 kHz) or 909 kbps (88.2/44.1 kHz) is selected.

Setting the BLUETOOTH standby mode

The BLUETOOTH standby mode enables the system to turn on automatically when you establish a BLUETOOTH connection from a BLUETOOTH device.

1 Press **OPTIONS**.

2 Press **▲/▼** repeatedly to select **"BT STBY"**, then press **[+]**.

3 Press **▲/▼** repeatedly to select the setting, then press **[+]**.

- **"ON"**: The system turns on automatically even when the system is in standby mode.
- **"OFF"**: Turns off this function.

To exit the options menu, press **OPTIONS**.

Turning on or off the BLUETOOTH signal

You can connect to the system from a paired BLUETOOTH device in all functions when the system's BLUETOOTH signal is set to on. The BLUETOOTH signal is turned on by default.

Hold down VOCAL FADER and  + on the unit for about 3 seconds.

"BT ON" or **"BT OFF"** appears on the display.

Note

- You cannot perform the following operations when BLUETOOTH signal is set to off:
 - Pair and/or connect with BLUETOOTH device
 - Use "Sony | Music Center"
 - Change the BLUETOOTH audio codecs
- If the BLUETOOTH standby mode is set to on, the BLUETOOTH signal will be set to on automatically.



Controlling the system using a smartphone or tablet (Sony | Music Center)

“Sony | Music Center” is a dedicated app for operating “Sony | Music Center”-compatible audio devices manufactured by Sony using a smartphone or tablet. Search for “Sony | Music Center” on Google Play or App Store and download it using your smartphone or tablet.

- “Sony | Music Center” allows you to:
- change the function of the system, control the playback of the disc/USB device and tune to an FM station.
 - browse the music content of disc/USB device.
 - view the information of disc/USB device such as playing time and title.
 - adjust the volume and change sound setting.
 - control multiple systems when using the Wireless Party Chain function.

- 1** Search for “Sony | Music Center” or scan the two-dimensional code below.



- 2** Download “Sony | Music Center” app on your device.

- 3** Connect the system and device via BLUETOOTH connection (page 41).

- 4** Launch “Sony | Music Center” and follow the on-screen instructions.

Note

- We recommend you to use the latest “Sony | Music Center” version.
- If the “Sony | Music Center” application does not work properly, press BLUETOOTH on the unit to terminate the BLUETOOTH connection, then perform the BLUETOOTH connection again so that the BLUETOOTH connection functions normally.
- Available operations via “Sony | Music Center” may differ depending on the audio devices.
- For more details on “Sony | Music Center”, refer to the following URL. <http://info.vssupport.sony.net/help/>
- Specifications and display design of “Sony | Music Center” are subject to change without notice.



Getting frenzied parties with the “Fiestable” app

You can control the party features of Sony’s Home Audio System with intuitive and fancy user interface with the “Fiestable” app. “Fiestable” allows you to control features such as DJ Effect, illumination and Karaoke. You can also enjoy the “Motion Control” function where you can operate certain features on this system by shaking your BLUETOOTH device in different directions. “Fiestable” is a plug-in application of “Sony | Music Center”.

- 1 Search and download “Sony | Music Center” app on your device (page 45).**
- 2 Search and download “Fiestable” app on Google Play or App Store using your device.**
- 3 Connect the system and device via BLUETOOTH connection (page 41).**
- 4 Launch “Sony | Music Center” and touch the “Fiestable” icon.**

Note

For more details on “Sony | Music Center”, refer to the following URL.
<http://info.vssupport.sony.net/help/>

Achieving and sharing a Party People ranking and getting bonus features with Party King

The system has a unique feature that can automatically record your system usage.

Based on your usage, the system will rank you with different Party People ranking according to predefined criteria. The frequent you use the system, the higher the ranking you will achieve.

Once you have achieved a certain Party People ranking, you can share your achievement through social media.

The system will also award your achievements with bonus features.

Note

To use this feature, make sure “Sony | Music Center” app (page 45) and “Fiestable” app (page 46) are already installed to your device.

- 1 Connect the system and device via BLUETOOTH connection (page 41).**
- 2 Launch “Sony | Music Center” and touch the “Fiestable” icon, then follow the on-screen instructions.**

You can check your current ranking, bonus features and also find out how to achieve next ranking.

Sound Adjustment

Adjusting the sound

To	Do this
Reinforce bass sound and create more powerful sound (MEGA BASS)	Press MEGA BASS repeatedly to select "BASS ON". To cancel, press MEGA BASS repeatedly to select "BASS OFF".
Reproduce the sound effect of a party hall (Fiesta)	Press FIESTA on the unit. Alternatively, press SOUND FIELD +/- (or SOUND FIELD on the unit) repeatedly to select "FIESTA". To cancel, press FIESTA again.
Select a sound field	Press SOUND FIELD +/- (or SOUND FIELD on the unit) repeatedly to select the sound field you want. To cancel, press SOUND FIELD +/- (or SOUND FIELD on the unit) repeatedly to select "FLAT".

Adjusting the subwoofer level (MHC-M80D only)

- 1 Press **OPTIONS**.
- 2 Press **↑/↓** repeatedly to select "S-WOOFER", then press .

- 3 Press **↑/↓** repeatedly to select the subwoofer level, then press .
To exit the options menu, press **OPTIONS**.

Selecting the Virtual Football mode

You can experience the feeling of being in the stadium when watching a football match broadcast. Note that you can only select Virtual Football mode during **AUDIO IN** and **TV** functions.

Press SOUND FIELD +/- repeatedly while watching a football match broadcast. (MHC-M40D only)
Alternatively, press FOOTBALL on the unit.

- "ON NARRATION": You can enjoy an immersive feeling of being in a football stadium through enhanced stadium cheers.
- "OFF NARRATION": You can enjoy a more immersive feeling of being in a football stadium by minimizing the volume level of narration in addition to the enhancement of cheers.

To cancel the Virtual Football mode

Press **SOUND FIELD +/-** repeatedly to select "FLAT".

Note

- We recommend that you select the Virtual Football mode when watching a football match broadcast.
- If you hear unnatural sounds in the content when "OFF NARRATION" is selected, "ON NARRATION" is recommended.

- This feature does not support monaural sound.

Creating your own sound effect

You can raise or lower the levels of specific frequency bands, then store the setting in the memory as "CUSTOM EQ".

- 1 Press OPTIONS.**
- 2 Press \uparrow/\downarrow repeatedly to select "CUSTOM EQ", then press $\boxed{+}$.**
- 3 Press \uparrow/\downarrow repeatedly to adjust the equalizer level or surround setting, then press $\boxed{+}$.**
- 4 Repeat step 3 to adjust the level of other frequency bands and surround effect.**
To exit the options menu, press OPTIONS.

To select the custom equalizer setting

Press SOUND FIELD +/- repeatedly to select "CUSTOM EQ".

Creating a party atmosphere (DJ Effect)

Use the buttons on the unit to perform this operation.

- 1 Press the following button to select the effect type.**
 - **FLANGER:** Creates a deep flanging effect that is similar to the roar of a jet plane.
 - **ISOLATOR:** Isolates a specific frequency band by adjusting the other frequency bands. For example, when you want to focus on vocals.
 - **SAMPLER:** Provides a series of special sound effects.
- 2 Change the sound effect.**

For FLANGER and ISOLATOR:

Turn the VOLUME/DJ CONTROL knob to adjust the effect level.

For SAMPLER:

Press SAMPLER repeatedly to select the sampler mode you want, then press S1, S2, S3 or S4 to output the sampler sound.

To output other sampler sound continuously, turn the VOLUME/DJ CONTROL knob.

To adjust the level of the sampler sound

- 1 Press OPTIONS on the remote control.**
- 2 Press \uparrow/\downarrow on the remote control repeatedly to select "SAMPLER", then press $\boxed{+}$.**
- 3 Press \uparrow/\downarrow on the remote control repeatedly to adjust the sampler sound level, then press $\boxed{+}$.**

To turn off the effect

- Press DJ OFF.
- Press the selected effect button again (for FLANGER and ISOLATOR only).

Note

- The DJ Effect is automatically turned off when you:
 - turn off the system.
 - change the function.
 - change sound effect.
 - use the Vocal Fader.
 - use the Voice Changer.
 - change the key (Key Control).
 - press DJ OFF on the unit.
- If you activate the DJ Effect during transferring, the sound effect will not be transferred onto the USB device.
- You cannot use VOLUME/DJ CONTROL knob on the unit to adjust the volume when the DJ Effect is activated. Press \triangleleft +/- on the remote control to adjust the volume.

Other Operations**Using the Control for HDMI function**

Connecting a TV compatible with the Control for HDMI function* by HDMI cable (High Speed HDMI Cable with Ethernet, not supplied) enables you to easily operate the device by a TV remote control.

The following functions can be used with the Control for HDMI function.

- System Power Off function
- System Audio Control function
- Audio Return Channel
- One-Touch Play function
- Remote Easy Control
- Language Follow

* Control for HDMI is a standard used by CEC (Consumer Electronics Control) for allowing HDMI (High-Definition Multimedia Interface) devices to control each other.

Note

These functions may work with devices other than those manufactured by Sony, but operation is not guaranteed.

Preparing to use the Control for HDMI function

Hold down SHIFT and press SETUP, then set [HDMI SETUP] – [CONTROL FOR HDMI] on the system to [ON] (page 35). The default setting is [ON].

Enable the Control for HDMI function settings for the TV connected to the system.

Hint

If you enable the Control for HDMI ("BRAVIA" sync) function when using a TV manufactured by Sony, the Control for HDMI function of the system is also enabled automatically. When settings are completed, "COMPLETE" appears on the display.

System Power Off function

When you turn off the TV, the system will turn off automatically.

Hold down SHIFT and press SETUP, then set [HDMI SETUP] – [STANDBY LINKED TO TV] on the system to [ON] or [AUTO] (page 36). The default setting is [AUTO].

Note

The connected device may not turn off depending on the status of the device.

System Audio Control function

If you turn on the system while you are watching the TV, the TV sound will be output from the speakers of the system. The volume of the system can be adjusted using the TV's remote control.

If the TV sound was output from the speakers of the system the previous time you watched the TV, the system will be turned on automatically when you turn on the TV again. Operations can also be made by the TV's menu. For details, refer to the operating instructions of your TV.

Note

- The system's volume level is displayed on the TV screen depending on the TV. It may differ from the volume level on the display.
- Depending on the settings of the TV, the System Audio Control function may not be available. For details, refer to the operating instructions of your TV.

Audio Return Channel

If the system is connected to a TV's HDMI IN jack compatible with Audio Return Channel, you can listen to TV sound from the speakers of the system without connecting an audio cable (not supplied).

Hold down SHIFT and press SETUP, then set [HDMI SETUP] – [AUDIO RETURN CHANNEL] to [ON] (page 36). The default setting is [ON].

Note

If the TV is not compatible with Audio Return Channel, an audio cable (not supplied) needs to be connected (page 23).

One-Touch Play function

When you press ► in DVD/CD or USB function, the TV is turned on automatically. The TV's input is switched to the HDMI input which the system is connected.

Note

Depending on the TV, the beginning part of content being played may not play correctly.

Remote Easy Control

You can select the system by the SYNC MENU button on the TV remote control and operate the system.

This function can be used if the TV supports the link menu. For details, refer to the operating instructions of your TV.

Note

- In the TV's link menu, the system is recognized by the TV as "Player".
- Some operations may not be available with some TVs.

Language Follow

When you change the language for the on-screen display of the TV, the system's on-screen display language is also changed.

Enjoying wireless playback using multiple systems (Wireless Party Chain function)

You can connect multiple audio systems in a chain via BLUETOOTH connection if all the systems are equipped with the Wireless Party Chain function. This function allows you to create a more exciting party environment and to produce higher sound output without a cable connection.

Note that you can only play back audio source from a BLUETOOTH device.

The first system in the chain to be activated becomes the Party Host and shares the music. Other systems become Party Guests and play the same music as that being played by the Party Host.

Setting up and enjoying the Wireless Party Chain

Example: setting the MHC-M80D as the first system (Party Host)

- 1 Turn on all the systems.
- 2 Set the first system as the Party Host.

- ① Press BLUETOOTH on the unit to select the BLUETOOTH function.
- ② Connect the BLUETOOTH device to the system via BLUETOOTH connection.

- ③ Press W.PARTY CHAIN on the unit.
"CHAINING" appears on the display. The system enter Wireless Party Chain setup mode.

When the system entered Wireless Party Chain setup mode, connection to the BLUETOOTH device is terminated automatically.

3 Set the second system as a Party Guest.

- ① Press BLUETOOTH on the second system to select the BLUETOOTH function.
- ② Press W.PARTY CHAIN on the second system.
The second system become a Party Guest.
"P.CHAIN" lights up on the display.

Note

The Wireless Party Chain function is canceled in the following situations.

- There is no operation within 1 minute after the Party Host is set in step 2.
- W.PARTY CHAIN is pressed again on the Party Host before step 3 is completed.

4 Set the third or more systems as Party Guests.

Repeat step 3.

Note

Connect the third or later systems within 30 seconds of connecting the previous system. "P.CHAIN" flashes on the display of the Party Host within 30 seconds. After 30 seconds, the system cannot be connected.

5 Wait 30 seconds after the last Party Guest is connected.

"P.CHAIN" will stop flashing on the display of the Party Host and the BLUETOOTH device will reconnect to the Party Host.

6 Start playback on the connected BLUETOOTH device.**7 Adjust the volume.**

When the volume on the Party Host is adjusted, the volume on Party Guests are also adjusted. If you want to adjust the volume on a particular Party Guest, adjust the volume on that Party Guest.

Note

- You cannot select another system as the new Party Host while the Wireless Party Chain is activated.
- When you use the microphone or play the guitar on Party Host, the sound will not be output from Party Guests.
- For detailed operation on other systems, refer to the operating instructions of the systems.

Hint

To add new Party Guests after Wireless Party Chain has already been established, hold down W.PARTY CHAIN on the Party Host and repeat the procedure from step 3.

To deactivate the Wireless Party Chain

Press W.PARTY CHAIN on Party Host.

Note

When you change the function or turn off the Party Host, the Wireless Party Chain will be deactivated.

To make a Party Guest leave the Wireless Party Chain

Press W.PARTY CHAIN on the Party Guest which want to leave. In this case, the rest of the Wireless Party Chain will remain active.

Note

- When you change the function or turn off a particular Party Guest, that Party Guest will leave the Wireless Party Chain connection.
- Sleep Timer and Auto Standby functions are not available on Party Guests.

Settings synchronization during Wireless Party Chain

When the Wireless Party Chain is established, the following conditions will be applied:

- Mega Bass, Party Light (MHC-M80D only) and Speaker Light (MHC-M80D/MHC-M60D only) settings on the Party Guests are synchronized with the Party Host. If these settings are changed on the Party Host, the settings on Party Guests are also changed.
- DJ Effect and Karaoke settings such as Vocal Fader and Key Control are turned off on both Party Host and Party Guests.
- Sound field settings return to default on both Party Host and Party Guests.
- When the Party Host is turned off, the Party Guests are also turned off.

Singing along: Karaoke

Preparing for Karaoke

- 1 Press the MIC LEVEL – repeatedly to reduce the microphone volume level.**
Alternatively, press MIC/GUITAR LEVEL – on the unit repeatedly to reduce the microphone volume level.
- 2 Press GUITAR on the unit repeatedly to select “OFF”.**
- 3 Connect an optional microphone with 6.3 mm plug to MIC1 or MIC2/GUITAR jack on the unit.**
Connect another optional microphone if you want to sing in duet.
- 4 Start playing the music and adjust the microphone volume. Press MIC ECHO repeatedly to adjust the echo effect.**
- 5 Start singing along with the music.**

Note

- We do not recommend using a microphone adaptor when connecting a microphone to MIC1 or MIC2/GUITAR jack.
- If howling occurs:
 - move the microphone away from the speakers.
 - change the direction of the microphone.
 - press the MIC LEVEL – repeatedly.
 - press MIC ECHO repeatedly to adjust the echo level.
- Microphone sound will not be transferred to the USB device during USB transfer.

- When using the Wireless Party Chain, sound from the microphone is only output from the system to which the microphone is connected.
- You cannot adjust the microphone volume level using the VOLUME/DJ CONTROL knob on the unit or \triangleleft +/- button on the remote control. Press the MIC LEVEL +/- repeatedly to adjust the microphone volume level.
- If the sound through the microphone is extremely loud, it may be distorted. Press MIC LEVEL – repeatedly to reduce the microphone volume.

Reducing the vocal sound (Vocal Fader)

You can reduce the sound of the vocal in stereo source.

Press VOCAL FADER repeatedly to select “ON V.FADER”.

To cancel Vocal Fader effect, press VOCAL FADER repeatedly to select “OFF”.

Changing the key (Key Control)

Press KEY CONTROL b/# to suit your vocal range.

Activating the Karaoke scoring mode (Score Mode)

You can only use scoring function when the microphone is connected. Your score is calculated from a scale of 0 to 99 by comparing your voice with the music source.

- 1 Start playing the music.**
- 2 Press SCORE before singing a song.**

- 3 After singing for more than a minute, press SCORE again to view your score.

Changing your voice (Voice Changer)

You can change your voice when you talk or sing into microphone.

Press VOICE CHANGER repeatedly to change your voice effect.

To turn off Voice Changer

Press VOICE CHANGER repeatedly to select "OFF".

Using the Voice Guidance

You can hear Voice Guidance when the system enters the BLUETOOTH pairing mode or a BLUETOOTH device is being connected or disconnected from the system.

- 1 Press OPTIONS.
- 2 Press \uparrow/\downarrow repeatedly to select "VOICE GUIDANCE", then press \oplus .
- 3 Press \uparrow/\downarrow repeatedly to select "ON", then press \oplus .

The Voice Guidance is activated. To exit the options menu, press OPTIONS.

To deactivate Voice Guidance

Repeat the steps in "Using the Voice Guidance" (page 54) and select "OFF" in step 3.

To adjust the level of the Voice Guidance

- 1 Press OPTIONS.
- 2 Press \uparrow/\downarrow repeatedly to select "SAMPLER", then press \oplus .
- 3 Press \uparrow/\downarrow repeatedly to adjust the Voice Guidance level, then press \oplus .

Note

- The Voice Guidance volume level change according to the system's volume level. However, in some cases, the Voice Guidance volume level may not change.
- In some cases, there may be a delay in Voice Guidance output.

Enjoying sound from a guitar

You can listen to the sound from the guitar by connecting a guitar to the MIC2/GUITAR jack on the unit. You can also play the guitar and sing along by connecting an optional microphone with 6.3 mm plug to the MIC1 jack on the unit. Your guitar sound can be changed by selecting the guitar effect.

- 1 Press MIC/GUITAR LEVEL – on the unit repeatedly to reduce the guitar volume level.
- 2 Use an instrument cable (not supplied) to connect a guitar (not supplied) to MIC2/GUITAR jack on the unit.

3 Press GUITAR on the unit repeatedly to select the guitar effect.

- “CLEAN”: original guitar sound. Recommended for electric guitar or electro-acoustic guitar.
- “O.DRIVE”: distorted sound similar to an overdriven guitar amplifier. Recommended for electric guitar.
- “BASS”: original guitar sound. Recommended for bass guitar.

4 Start playing the guitar and adjust the guitar volume.

The guitar sound is output from the system.

Note

- We do not recommend using a microphone adaptor when connecting a microphone to MIC1 jack.
- Howling may occur when using electro-acoustic guitar with “O.DRIVE” effect. Press MIC/GUITAR LEVEL – on the unit repeatedly to reduce the guitar volume. Otherwise, change to the other guitar effect.
- Before disconnecting the guitar from the system, press MIC/GUITAR LEVEL – on the unit repeatedly to reduce the guitar volume.

To turn off the guitar mode

Press GUITAR on the unit repeatedly to select “OFF”.

Enjoying music with the Party Light and Speaker Light (MHC-M80D/MHC-M60D only)

Note

Party Light is available for MHC-M80D only.

1 Press PARTY LIGHT repeatedly to select “LED ON”.

Alternatively, press SPEAKER LIGHT on the unit repeatedly to select “LED ON” (MHC-M60D only).

2 Press LIGHT MODE repeatedly to select the illumination mode you want.

The illumination mode will be different when Wireless Party Chain is activated.

To turn off Party Light and Speaker Light

Press PARTY LIGHT repeatedly to select “LED OFF”.

Note

- Do not look directly at the light-emitting part when the Party Light (MHC-M80D only) and Speaker Light are turned on.
- If the illumination brightness is glaring, switch on the room lights or turn off the illumination.
- You can turn on or off the Party Light (MHC-M80D only) and Speaker Light when demonstration is turned on.

Using the Sleep Timer

The system turns off automatically after the preset time.

Press SLEEP repeatedly to select the time you want.

To cancel Sleep Timer, press SLEEP repeatedly to select "OFF".

Hint

To check the remaining time before the system turns off, press SLEEP.

Using optional equipment

- 1 Press \blacktriangleleft - repeatedly until "VOL MIN" appears on the display.
- 2 Connect an optional equipment (page 19).
- 3 Press FUNCTION repeatedly to select "AUDIO IN".
- 4 Start playing the connected equipment.
- 5 Press \blacktriangleleft + repeatedly to adjust the volume.

Note

The system may enter standby mode automatically if the volume level of the connected equipment is too low. Adjust the volume level of the equipment. To turn off automatic standby function, see "Setting the automatic standby function" (page 56).

Deactivating the buttons on the unit (Child Lock)

You can deactivate the buttons (except \odot) on the unit to prevent misoperation, such as child mischief.

Hold down \blacksquare on the unit for more than 5 seconds.

"CHILD LOCK ON" appears on the display.

You can only operate the system using the buttons on the remote control.

To turn off the Child Lock function, hold down \blacksquare on the unit for more than 5 seconds until "CHILD LOCK OFF" appears on the display.

Note

- Child Lock function will be turned off automatically when you disconnect the AC power cord (mains lead).
- Child Lock function cannot be activated when you open the disc tray.

Setting the automatic standby function

The system enters standby mode automatically in about 15 minutes when there is no operation or audio signal output.

By default, the automatic standby function is turned on.

- 1 Press OPTIONS.
- 2 Press \blacktriangleleft / \blacktriangleright repeatedly to select "AutoSTBY", then press $\boxed{+}$.

3 Press \uparrow/\downarrow repeatedly to select "ON" or "OFF", then press \oplus .

To exit the options menu, press OPTIONS.

Note

- "AutoSTBY" flashes on the display about 2 minutes before entering standby mode.
- The automatic standby function does not work in the following cases:
 - during tuner function.
 - when the Sleep Timer is activated.
 - when microphone or guitar is connected.
 - when the system become Party Guest during Wireless Party Chain.

Updating the software

The software of this system may be updated in the future.

You can update your system's pre-installed software from the websites below.

Follow the online instructions to update the software.

For customers in Latin America:

<<http://esupport.sony.com/LA>>

For customers in Europe and Russia:

<<http://www.sony.eu/support>>

For customers in other countries/regions:

<<http://www.sony-asia.com/support>>

Additional Information

Troubleshooting

Should you encounter a problem with your system, find your problem in the troubleshooting checklist below and take the corrective action.

If the problem persists, consult your nearest Sony dealer.

Note that if the service personnel changes some parts during repair, these parts may be retained.

If "PROTECTX" (X is a number) and "CHECK MANUAL" flashes on the display

Immediately unplug the AC power cord (mains lead), and check the following items.

- Are you using only the supplied speakers?
- Is anything blocking the ventilation holes of the unit?

After you have checked and found no problems, reconnect the AC power cord (mains lead), and turn on the system. If the issue persists, contact your nearest Sony dealer.

General

The power does not turn on.

- Check that the AC power cord (mains lead) is connected securely.

The system has entered standby mode.

- This is not a malfunction. The system enters standby mode automatically in about 15 minutes when there is no operation or audio signal output (page 56).

There is no sound.

- Adjust the volume.
- Check the speaker connections (page 19).
- Check the connection of the optional equipment, if any (page 19).
- Turn on the connected equipment.
- Unplug the AC power cord (mains lead), then plug in the AC power cord (mains lead) again and turn on the system.

There is no picture/sound when connected to the HDMI OUT (TV) ARC jack.

- Change the setting in [HDMI SETUP] – [HDMI RESOLUTION]. The problem may be solved.
- The equipment connected to the HDMI OUT (TV) ARC jack does not conform to the audio signal format. In this case, set [HDMI SETUP] – [AUDIO(HDMI)] to [PCM] (page 35).
- Try the following:
 - Turn the system off and on again.
 - Turn the connected equipment off and on again.
 - Disconnect then connect the HDMI cable again.

There is no microphone sound.

- Adjust the microphone volume level.
- Make sure the microphone is connected to the MIC1 or MIC2/GUITAR jack on the unit correctly.
- Make sure the microphone is turned on.

Microphone adaptor (not supplied) cannot be removed.

- Use a tool such as plier to disconnect the microphone adaptor from MIC1 or MIC2/GUITAR jack on the unit.

No TV sound is heard from the system. "CODE 01" and "SGNL ERR" appear on the display.

- This system supports 2-channel Linear PCM formats only. Check the audio output setting on the TV and change it to PCM output mode if automatic mode is selected.
- Check that the speaker output setting on the TV is set to use external speakers.

There is severe hum or noise.

- Move the system away from sources of noise.
- Connect the system to a different wall outlet.
- Install a noise filter (not supplied) to the AC power cord (mains lead).
- Turn off surrounding electrical equipment.
- The noise generated by the cooling fans of the system may be heard when the system is turned on. This is not a malfunction.
- Move the unit away from the neon signs or fluorescent light.

The remote control does not function.

- Remove the obstacles between the remote control and the unit.
- Move the remote control closer to the unit.
- Point the remote control at the unit's sensor.
- Replace the batteries (R03/size AAA).
- Move the unit away from the fluorescent light.

There is acoustic feedback.

- Reduce the volume.
- Move the microphone and guitar away from the system or change the direction of the microphone.

The color irregularity on a TV screen persists.

- Turn off the TV at once, then turn it on after 15 to 30 minutes. If the color irregularity still persists, place the system farther away from the TV.

"CHILD LOCK" appears when you press any button on the unit.

- Set the Child Lock function to off (page 56).

A clicking sound is heard when system is turned on.

- This is the operating sound and it occurs when the system is turned on or off, for example. This is not a malfunction.

The sound loses stereo effect during playback.

- Turn off the Vocal Fader (page 53).
- Make sure the system is connected properly.
- Check the speaker connections (page 18).

Speakers

Sound comes from only one channel or the left and right volume is unbalanced.

- Place the speakers as symmetrically as possible.
- Check that the speakers are connected securely and correctly.
- The source being played back is monaural.

There is no sound from a specific speaker.

- Check that the speaker is connected securely and correctly.

Disc player

The disc tray does not open and "LOCKED" appears on the display.

- Consult your nearest Sony dealer or local authorized Sony service facility.

The disc tray does not close.

- Load the disc correctly.

The disc does not eject.

- You cannot eject the disc during Synchronized Transfer or REC1 Transfer. Press ■ to cancel the transfer, then press ▲ on the unit to eject the disc.
- Consult your nearest Sony dealer.

Playback does not start.

- Wipe the disc clean (page 67).
- Reload the disc.
- Load the disc that this system can play back (page 8).
- Remove the disc and wipe away the moisture on the disc, then leave the system turned on for a few hours until the moisture evaporates.
- The region code on the DVD VIDEO does not match the system.

The sound skips.

- Wipe the disc clean (page 67).
- Reload the disc.
- Move the unit to a place with no vibration.
- Move the speakers away from the unit. When you listen to a track with bass sounds at high volume, the speaker vibration may cause the sound to skip.

Playback does not start from the first track.

- Set the play mode to Normal Play (page 29).
- Resume Play has been selected. Press ■ twice. Then, press ► to start playback.

You cannot perform some functions such as Stop, Lock Search, Slow-motion Play, Repeat Play, or Shuffle Play.

- Depending on the disc, you may not be able to do some of the operations above. Refer to the operating instructions supplied with the disc.

The DATA CD/DATA DVD (MP3, MPEG4, or Xvid) cannot be played back.

- The data is not stored in the supported format.
- Make sure you have selected the correct Media Mode before playback.

The folder name, track name, file name and ID3 tag characters do not appear properly.

- The ID3 tag is not Version 1 (1.0/1.1) or Version 2 (2.2/2.3).
- The character codes that can be displayed by this system are as follows:
 - Upper cases (A to Z)
 - Numbers (0 to 9)
 - Symbols (<> * +, [] \ _)Other characters appear as “ _ ”.

USB device

Transferring results in an error.

- You are using an unsupported USB device. Check the information on the website about compatible USB devices (page 11).

- The USB device is not formatted correctly. Refer to the operating instructions of the USB device on how to format.
- Turn off the system and remove the USB device. If the USB device has a power switch, turn the USB device off and on again after removing it from the system. Then, perform the transfer again.
- If the transfer and erase operations are repeated multiple times, the file structure within the USB device becomes fragmented. Refer to the operating instructions of the USB device on how to deal with this problem.
- The USB device was disconnected or the power was turned off during transfer. Delete the partially-transferred file, and perform the transfer again. If this does not fix the problem, the USB device may be broken. Refer to the operating instructions of the USB device on how to deal with this problem.

Audio files or folders on the USB device cannot be erased.

- Check if the USB device is write-protected.
- The USB device was disconnected or the power was turned off during the erase operation. Delete the partially-erased file. If this does not fix the problem, the USB device may be broken. Refer to the operating instructions of the USB device on how to deal with this problem.

There is no sound.

- The USB device is not connected correctly. Turn off the system and reconnect the USB device, then turn on the system and check if “USB” appears on the display.



There is noise, skipping, or distorted sound.

- You are using an unsupported USB device. Check the information on the website about compatible USB devices (page 11).
- Turn off the system and reconnect the USB device, then turn on the system.
- The music data itself contains noise, or the sound is distorted. Noise may have entered during the transfer process. Delete the file, and try transfer again.
- The bit rate used in encoding an audio file was low. Send an audio file with higher bit rate to the USB device.

“READING” is displayed for an extended time, or it takes a long time before playback starts.

- The reading process can take a long time in the following cases.
 - There are many folders or files on the USB device (page 10).
 - The file structure is extremely complex.
 - The memory capacity is excessive.
 - The internal memory is fragmented.

“NO FILE” appears on the display.

- The system has entered the software update mode, and all buttons (except ) are deactivated. Press  on the unit to cancel the software update.

“OVER CURRENT” appears on the display.

- A problem has been detected with the level of electrical current from the  (USB) port. Turn off the system and remove the USB device from the port. Make sure there is no problem with the USB device. If this display pattern persists, contact your nearest Sony dealer.

Erroneous display.

- The data stored in the USB device may have been corrupted, perform the transfer again.
- The character codes that can be displayed by this system are as follows:
 - Upper cases (A to Z)
 - Numbers (0 to 9)
 - Symbols (< > * +, [] \ _)
 Other characters appear as “ _ ”.

The USB device is not recognized.

- Turn off the system and reconnect the USB device, then turn on the system.
- Check the information on the website about compatible USB devices (page 11).
- The USB device is not working properly. Refer to the operating instructions of the USB device on how to deal with this problem.

Playback does not start.

- Turn off the system and reconnect the USB device, then turn on the system.
- Check the information on the website about compatible USB devices (page 11).

Playback does not start from the first file.

- Set the play mode to Normal Play (page 29).

Files cannot be played back.

- Make sure you have selected the correct Media Mode before playback.
- USB devices formatted with file systems other than FAT16 or FAT32 are unsupported.*
- If you use a partitioned USB device, only files on the first partition can be played back.

* This system supports FAT16 and FAT32, but some USB devices may not support all of these FAT. For details, refer to the operating instructions of each USB device or contact the manufacturer.

Picture

There is no picture.

- Check that the system is connected securely.
- If the HDMI cable is damaged, replace it with a new one.
- Make sure you connect the unit to the HDMI input jack on your TV (page 22).
- Make sure you turn on the TV and operate the TV correctly.
- Make sure you select the input according to the connection on the TV so that you can view the pictures from the system.
- (Except for Latin American, European, and Russian models) Make sure you set the color system correctly, according to your TV's color system.

Picture noise appears.

- Wipe the disc clean (page 67).
- (Except for Latin American, European, and Russian models) When you play back a VIDEO CD recorded in a different color system from the one you set to the system, the picture image may be distorted (page 24, 34).

- (Except for Latin American, European, and Russian models) Set the color system to match your TV (page 24, 34).

The aspect ratio of the TV screen cannot be changed.

- The aspect ratio is fixed on your DVD VIDEO and video file.
- Depending on the TV, you may not change the aspect ratio.

The language for the sound track cannot be changed.

- Multilingual tracks are not recorded on the DVD VIDEO being played back.
- The DVD VIDEO prohibits changing the language for the sound track.

The subtitles language cannot be changed.

- Multilingual subtitles are not recorded on the DVD VIDEO being played back.
- The DVD VIDEO prohibits changing the subtitles.

The subtitles cannot be turned off.

- The DVD VIDEO prohibits turning off subtitles.

The camera angles cannot be changed.

- Multi-angles are not recorded on the DVD VIDEO being played back.
- The DVD VIDEO prohibits changing the angles.

Tuner*

There is severe hum or noise, or stations cannot be received.

- Connect the antenna properly.
- Change antenna location and its orientation to obtain good reception.
- Turn off nearby electrical equipment.

- * Radio may not be received depending on the radio wave conditions or the housing environment in your area.

BLUETOOTH device

Pairing cannot be performed.

- Move the BLUETOOTH device closer to the system.
- Pairing may not be possible if other BLUETOOTH devices are present around the system. In this case, turn off the other BLUETOOTH devices.
- Make sure to enter the correct passkey when selecting the system's name (this system) on the BLUETOOTH device.

The BLUETOOTH device cannot detect the system, or "BT OFF" appears on the display.

- Set the BLUETOOTH signal to "BT ON" (page 44).

Connection is not possible.

- The BLUETOOTH device you attempted to connect does not support the A2DP profile, and cannot be connected with the system.
- Enable the BLUETOOTH function of the BLUETOOTH device.
- Establish a connection from the BLUETOOTH device.
- The pairing registration information has been erased. Perform the pairing operation again.

The sound skips or fluctuates, or the connection is lost.

- The system and the BLUETOOTH device are too far apart.
- If there are obstacles between the system and your BLUETOOTH device, remove or avoid the obstacles.

- If there is equipment that generates electromagnetic radiation, such as a wireless LAN, other BLUETOOTH device, or a microwave oven nearby, move them away.

The sound of your BLUETOOTH device cannot be heard on this system.

- Increase the volume on your BLUETOOTH device first, then adjust the volume using \triangle +/-.

There is severe hum, noise, or distorted sound.

- If there are obstacles between the system and your BLUETOOTH device, remove or avoid the obstacles.
- If there is equipment that generates electromagnetic radiation, such as a wireless LAN, other BLUETOOTH device, or a microwave oven nearby, move them away.
- Turn down the volume of the connected BLUETOOTH device.

Control for HDMI ("BRAVIA" Sync)

The system does not turn on even when the TV is turned on.

- Hold down SHIFT and press SETUP, then set [HDMI SETUP] – [CONTROL FOR HDMI] to [ON] (page 35). The TV must support the Control for HDMI function (page 49). For details, refer to the operating instructions of your TV.
- Check the speaker settings of the TV. The system power syncs with the speaker settings of the TV. For details, refer to the operating instructions of your TV.

- If the sound was output from the TV's speakers the previous time, the system does not turn on even when the TV is turned on.

The system turns off when the TV is turned off.

- Check the setting of [HDMI SETUP] – [STANDBY LINKED TO TV] (page 36). When [STANDBY LINKED TO TV] is set to [ON], the system turns off automatically when you turn off the TV regardless of the input.

The system does not turn off even when the TV is turned off.

- Check the setting of [HDMI SETUP] – [STANDBY LINKED TO TV] (page 36). To turn the system off automatically regardless of the input when you turn off the TV, set [STANDBY LINKED TO TV] to [ON]. The TV must support the Control for HDMI function (page 49). For details, refer to the operating instructions of your TV.

No TV sound is output from the system.

- Check the type and connection of the HDMI cable or audio cable that is connected to the system and the TV (page 22).
- If your TV is compatible with Audio Return Channel, make sure the system is connected to an ARC-compatible HDMI IN jack of the TV (page 22). If sound is still not output or if sound is interrupted, connect an audio cable (not supplied), hold down SHIFT and press SETUP, then set [HDMI SETUP] – [AUDIO RETURN CHANNEL] to [OFF] (page 36).

- If your TV is not compatible with Audio Return Channel, TV sound will not be output from the system even if the system is connected to the TV's HDMI IN jack. To output TV sound from the system, connect an audio cable (not supplied) (page 23).
- Change the function of the system to "TV" (page 23).
- Increase the volume on the system.
- Depending on the order in which you connect the TV and the system, the system may be muted and "M" (muting) lights up on the display of the unit. If this happens, turn on the TV first, then the system.
- Set the speakers setting of the TV (BRAVIA) to Audio System. Refer to the operating instructions of your TV on how to set the TV.

The sound is output from both the system and the TV.

- Mute the sound of the system or the TV.
- Change the speaker output on the TV to TV speaker or Audio System.

The Control for HDMI function does not work properly.

- Check the connection with the system (page 17).
- Enable the Control for HDMI function on the TV. For details, refer to the operating instructions of your TV.
- Wait a while, then try again. If you unplug the system, it will take a while before operations can be made. Wait for 15 seconds or longer, then try again.
- Make sure the TV connected to the system support the Control for HDMI function.

- The type and number of devices that can be controlled by the Control for HDMI function is restricted by the HDMI CEC standard as follows:
 - Recording devices (Blu-ray Disc recorder, DVD recorder, etc.): up to 3 devices
 - Playback devices (Blu-ray Disc Player, DVD player, etc.): up to 3 devices (this system uses one of them)
 - Tuner-related devices: up to 4 devices
 - Audio system (receiver/headphone): up to 1 device (used by this system)

Wireless Party Chain



BLUETOOTH device cannot be connected to the system during Wireless Party Chain function.

- After connecting all the systems, perform the pairing and connecting operations between the BLUETOOTH device and the Party Host.

Resetting the system

If the system still does not operate properly, reset the system to factory default settings.

Use the buttons on the unit to perform this operation.

- 1 Unplug the AC power cord (mains lead), then plug it back in.
- 2 Press  to turn on the system.
- 3 Hold down VOCAL FADER and MIC ECHO for about 3 seconds. "RESET" appears on the display. After the reset completes, the system automatically reboots. Press  to turn on the system.

All BLUETOOTH pairing information and user-configured settings, such as preset radio stations are reset to factory default setting (except for some setup menu settings).



To reset all setup menu settings, see "Returning the setup menu settings to the default" (page 65).



Returning the setup menu settings to the default



You can return the setup menu settings (except for [PARENTAL CONTROL] settings) to the default settings.

- 1 Hold down SHIFT and press SETUP.

The setup menu appears on the TV screen.

- 2 Press / repeatedly to select [SYSTEM SETUP], then press .

- 3 Press / repeatedly to select [RESET], then press .

- 4 Press / repeatedly to select [YES], then press .

It takes a few seconds to complete. Do not press  while resetting the system.

Self-diagnosis Function

When letters/numbers appear on the TV screen or the display

When the self-diagnosis function is activated to prevent the system from malfunctioning, a service number appears. The service number consists of an alphabet and numerals (e.g. C 13 50). See the following table for the cause and corrective action.

First 3 characters of the service number	Cause and corrective action
C 13	This disc is dirty. <ul style="list-style-type: none"> Clean the disc with a soft cloth (page 67).
C 31	The disc is not inserted correctly. <ul style="list-style-type: none"> Turn off the system, then turn it back on again. Then re-insert the disc correctly.
E XX (XX is a number)	To prevent a malfunction, the system has performed the self-diagnosis function. <ul style="list-style-type: none"> Contact your nearest Sony dealer or local authorized Sony service facility and give the 5-character service number. Example: E 61 10

Messages

One of the following messages may appear or flash on the display during operation.

CANNOT PLAY

- A disc that cannot be played back was inserted.
- A DVD VIDEO with unsupported region code was inserted.

CODE 01/SGNL ERR

An unsupported audio signal is input from the connected TV's HDMI IN (ARC) jack (page 22).

DATA ERROR

- The file is created in unsupported format.
- The file extensions does not match the file format.

DEVICE ERROR

The USB device could not be recognized or an unknown device is connected.

DEVICE FULL

The memory of the USB device is full.

ERASE ERROR

Erase of audio files or folders on the USB device failed.

FATAL ERROR

The USB device was removed during transfer or erase operation, and may have been damaged.

FOLDER FULL

You cannot transfer onto the USB device because the number of folders has reached its maximum.

NoDEVICE

No USB device is connected or unsupported device is connected.

NO DISC

There is no disc in the unit.

NO MUSIC

No supported audio files exist in the playback source.

NO VIDEO

No supported video files exist in the playback source.

NOT USE

You tried to perform a specific operation under conditions where that operation is prohibited.

NO SUPPORT

An unsupported USB device is connected, or the USB device is connected through a USB hub.

OVER CURRENT

An over current from the  (USB) port was detected.

PROTECT

The USB device is write-protected.

PUSH STOP

You tried to perform an operation that can be performed only when the playback is stopped.

READING

The system is reading information of the disc or USB device. Some operations are not available.

REC ERROR

The transfer did not start, stopped partway, or otherwise could not be performed.

TRACK FULL

You cannot transfer onto the USB device because the number of files has reached its maximum.

Precautions

When carrying the unit

To avoid damaging the disc mechanism, perform the following procedure before carrying the unit.

Use the buttons on the unit to perform this operation.

1 Press  to turn on the system.

2 Press **FUNCTION** repeatedly to select "DVD/CD".

3 Remove the disc.

Press  to open and close the disc tray.

Wait until "NO DISC" appears on the display.

4 Press  to turn off the system.

5 Unplug the AC power cord (mains lead).

Notes on discs

- Before playing, wipe the disc with a cleaning cloth from the center outward to the edge.
- Do not clean discs with solvents, such as benzine, thinner, or commercially available cleaners or anti-static spray intended for vinyl LPs.
- Do not expose discs to direct sunlight or heat sources such as hot air ducts, nor leave them in a car parked in direct sunlight.

On safety

- Completely disconnect the AC power cord (mains lead) from the wall outlet (mains) if it is not going to be used for an extended period of time. When unplugging the unit, always grip the plug. Never pull the cord itself.
- Should any solid object or liquid get into the system, unplug the system, and have it checked by qualified personnel before operating it again.
- AC power cord (mains lead) must be changed only at the qualified service shop.

On handling the system

This system is not drip-proof or waterproof. Make sure not to splash water on the system or clean it with water.

On placement

- Do not place the system in an inclined position or in locations that are extremely hot, cold, dusty, dirty, or humid or lacking adequate ventilation, or subject to vibration, direct sunlight or a bright light.
- Be careful when placing the unit or speakers on surfaces that have been specially treated (for example, wax, oil, polish) as staining or discoloration of the surface may result.

- If the system is brought directly from a cold to a warm location or is placed in a very damp room, moisture may condense on the lens inside the unit, and cause the system to malfunction. In this situation, remove the disc, and leave the system turned on for about an hour until the moisture evaporates.

On heat buildup

- Heat buildup on the unit during operation is normal and is not a cause for alarm.
- Do not touch the cabinet if it has been used continuously at a high volume because the cabinet may have become hot.
- Do not obstruct the ventilation holes.

On the speaker system

The speaker system is not magnetically shielded, and the picture on nearby TV sets may become magnetically distorted. In this situation, turn off the TV, wait 15 to 30 minutes, and turn it back on. If there is no improvement, move the speakers far away from the TV.

IMPORTANT NOTICE

Caution: If you leave a still video image or on-screen display image displayed on your TV for an extended period of time via this system, you risk permanent damage to your TV screen. Projection TVs are especially susceptible to this.

Cleaning the cabinet

Clean this system with a soft cloth slightly moistened with a mild detergent solution. Do not use any type of abrasive pad, scouring powder, or solvent, such as thinner, benzine, or alcohol.

On BLUETOOTH communication

- BLUETOOTH devices should be used within approximately 10 meters (unobstructed distance) of each other. The effective communication range may become shorter under the following conditions.

- When a person, metal object, wall or other obstruction is between the devices with a BLUETOOTH connection
- Locations where a wireless LAN is installed
- Around microwave ovens that are in use
- Locations where other electromagnetic waves are generated
- BLUETOOTH devices and wireless LAN (IEEE 802.11b/g/n) equipment use the same frequency band (2.4 GHz). When using your BLUETOOTH device near a device with wireless LAN capability, electromagnetic interference may occur. This could result in lower data transfer rates, noise, or inability to connect. If this happens, try the following remedies:
 - Use this system at least 10 meters away from the wireless LAN equipment.
 - Turn off the power of the wireless LAN equipment when using your BLUETOOTH device within 10 meters.
 - Use this system and BLUETOOTH device as closer to each other as possible.
- The radio waves broadcast by this system may interfere with the operation of some medical devices. Since this interference may result in malfunction, always turn off the power on this system and BLUETOOTH device in the following locations:
 - In hospitals, on trains, in airplanes, at gas stations, and any place where flammable gases may be present
 - Near automatic doors or fire alarms
- This system supports security functions that comply with BLUETOOTH specifications to ensure secure connections during communication using BLUETOOTH technology. However, this security may be insufficient depending on the setting contents and other factors, so always be careful when performing communication using BLUETOOTH technology.

- Sony cannot be held liable in any way for damages or other loss resulting from information leaks during communication using BLUETOOTH technology.
- BLUETOOTH communication is not necessarily guaranteed with all BLUETOOTH devices that have the same profile as this system.
- BLUETOOTH devices connected with this system must comply with the BLUETOOTH specification prescribed by the Bluetooth SIG, Inc., and must be certified to comply. However, even when a device complies with the BLUETOOTH specification, there may be cases where the characteristics or specifications of the BLUETOOTH device make it impossible to connect, or may result in different control methods, display or operation.
- Noise may occur or the audio may cut off depending on the BLUETOOTH device connected with this system, the communications environment, or surrounding conditions.

Specifications

Inputs

AUDIO IN (TV) L/R:

Voltage 2 V, impedance
47 kilohms

TV (ARC):

Supported audio signal:
2-channel Linear PCM

MIC1:

Sensitivity 1 mV, impedance
10 kilohms

MIC2/GUITAR:

Sensitivity 1 mV, impedance
10 kilohms (When guitar mode is
turned off.)

Sensitivity 200 mV, impedance
250 kilohms (When guitar mode is
turned on.)

Outputs

HDMI OUT (TV) ARC:

Supported audio signal:
2-channel Linear PCM (up to
48 kHz), Dolby Digital

HDMI section

Connector:

Type A (19 pin)

Disc player section

System:

Compact disc and digital audio
and video system

Laser Diode Properties

Emission Duration: Continuous

Laser Output*: Less than 44.6 μ W

* This output is the value
measurement at a distance of
200 mm from the objective lens
surface on the Optical Pick-up
Block with 7 mm aperture.

Frequency response:

20 Hz – 20 kHz

Video color system format:

Latin American model:

NTSC

Other models:

NTSC and PAL

USB section

Supported USB device:

Mass Storage Class

Maximum current:

1 A

↔ (USB) port:

Type A

FM tuner section

FM stereo, FM superheterodyne tuner

Antenna:

FM lead antenna

Tuning range:

87.5 MHz – 108.0 MHz (50 kHz
step)

BLUETOOTH section

Communication system:

BLUETOOTH Standard version 4.2

Output:

BLUETOOTH Standard Power
Class 2

Maximum output power:

< 9.5 dBm

Maximum communication range:

Line of sight approx. 10 m^{*1}

Maximum number of devices to be registered

8 devices

Maximum number of simultaneous connection (Multipoint)

3 devices

Frequency band:

2.4 GHz band (2.4000 GHz –
2.4835 GHz)

Modulation method:

FHSS (Freq Hopping Spread
Spectrum)

Compatible BLUETOOTH profiles^{*2}:

A2DP (Advanced Audio
Distribution Profile)
AVRCP (Audio Video Remote
Control Profile)
SPP (Serial Port Profile)

Supported codecs:

SBC (Subband Codec)
AAC (Advanced Audio Coding)
LDAC

^{*1} The actual range will vary depending on factors such as obstacles between devices, magnetic fields around a microwave oven, static electricity, reception sensitivity, antenna's performance, operating system, software application, etc.

^{*2} BLUETOOTH standard profiles indicate the purpose of BLUETOOTH communication between devices.

Supported audio formats

Supported bit rate and sampling frequencies:

MP3:

32/44.1/48 kHz, 32 kbps –
320 kbps (VBR)

AAC:

44.1 kHz, 48 kbps – 320 kbps
(CBR/VBR)

WMA:

44.1 kHz, 48 kbps – 192 kbps
(CBR/VBR)

WAV:

44.1/48 kHz (16 bit)

Supported video formats

Xvid:

Video codec: Xvid video

Bit rate: 4.854 Mbps (MAX)

Resolution/Frame rate:

720 × 480, 30 fps

720 × 576, 25 fps (except for Latin
American model)

Audio codec: MP3

MPEG4:

File format: MP4 File Format

Video codec: MPEG4 Simple

Profile (AVC is not compatible.)

Bit rate: 4 Mbps

Resolution/Frame rate:

720 × 480, 30 fps

720 × 576, 25 fps (except for Latin
American model)

Audio codec: AAC-LC (HE-AAC is
not compatible.)

DRM: Not compatible

Speaker System

SS-WM80D

Speaker system:

1-way, Bass Reflex

Speaker unit:

Subwoofer: 250mm, cone type

Rated impedance:

3 ohms

Dimensions (w/h/d) (Approx.):
340 mm × 405 mm × 315 mm

Mass (Approx.):
8.5 kg

SS-M80D

Speaker system:

3-way, Bass Reflex

Speaker unit:

Mid: 80 mm, cone type
Tweeters: 50 mm, cone type
Woofers: 200 mm, cone type

Rated impedance:

Mid/Tweeter: 8 ohms
Woofers: 3 ohms

Dimensions (w/h/d) (Approx.):
285 mm × 405 mm × 350 mm

Mass (Approx.):
7.4 kg

SS-M60D

Speaker system:

3-way, Bass Reflex

Speaker unit:

Mid: 80 mm, cone type
Tweeters: 50 mm, cone type
Woofers: 200 mm, cone type

Rated impedance:

Mid/Tweeter: 8 ohms
Woofers: 3 ohms

Dimensions (w/h/d) (Approx.):
285 mm × 405 mm × 310 mm

Mass (Approx.):
7.2 kg

SS-M40D

Speaker system:

2-way, Bass Reflex

Speaker unit:

Tweeters: 50 mm, cone type
Woofers: 200 mm, cone type

Rated impedance:

6 ohms

Dimensions (w/h/d) (Approx.):
255 mm × 405 mm × 220 mm

Mass (Approx.):
5.1 kg

General

Power requirements:

AC 120 V – 240 V, 50/60 Hz

Power consumption:

MHC-M80D: 390 W

MHC-M60D: 290 W

MHC-M40D: 120 W

Power consumption (at the Power Saving mode):

0.5 W (When "BT STBY" is set to "OFF" and [CONTROL FOR HDMI] is set to [OFF].)

2 W* (When "BT STBY" is set to "ON" and [CONTROL FOR HDMI] is set to [ON].)

Dimensions (w/h/d) (excl. speakers) (Approx.):

335 mm × 172 mm × 310 mm

Mass (excl. speakers) (Approx.):

HCD-M80D: 4.0 kg

HCD-M60D: 3.8 kg

HCD-M40D: 2.9 kg

Operating temperature:

5 °C to 35 °C

* The power consumption of the system will be less than 0.5 W when there is no HDMI connection and "BT STBY" is set to "OFF".

Design and specifications are subject to change without notice.

Language code list

The language spellings conform to the ISO 639:1988 (E/F) standard.

Code	Language	Code	Language	Code	Language	Code	Language
1027	Afar	1186	Scots Gaelic	1350	Malayalam	1513	Siswati
1028	Abkhazian	1194	Galician	1352	Mongolian	1514	Sesotho
1032	Afrikaans	1196	Guarani	1353	Moldavian	1515	Sundanese
1039	Amharic	1203	Gujarati	1356	Marathi	1516	Swedish
1044	Arabic	1209	Hausa	1357	Malay	1517	Swahili
1045	Assamese	1217	Hindi	1358	Maltese	1521	Tamil
1051	Aymara	1226	Croatian	1363	Burmese	1525	Telugu
1052	Azerbaijani	1229	Hungarian	1365	Nauru	1527	Tajik
1053	Bashkir	1233	Armenian	1369	Nepali	1528	Thai
1057	Byelorussian	1235	Interlingua	1376	Dutch	1529	Tigrinya
1059	Bulgarian	1239	Interlingue	1379	Norwegian	1531	Turkmen
1060	Bihari	1245	Inupiak	1393	Occitan	1532	Tagalog
1061	Bislama	1248	Indonesian	1403	(Afan) Oromo	1534	Setswana
1066	Bengali; Bangla	1253	Icelandic	1408	Oriya	1535	Tonga
1067	Tibetan	1254	Italian	1417	Punjabi	1538	Turkish
1070	Breton	1257	Hebrew	1428	Polish	1539	Tsonga
1079	Catalan	1261	Japanese	1435	Pashto; Pushto	1540	Tatar
1093	Corsican	1269	Yiddish	1436	Portuguese	1543	Twi
1097	Czech	1283	Javanese	1463	Quechua	1557	Ukrainian
1103	Welsh	1287	Georgian	1481	Rhaeto-Romance	1564	Urdu
1105	Danish	1297	Kazakh	1482	Kirundi	1572	Uzbek
1109	German	1298	Greenlandic	1483	Romanian	1581	Vietnamese
1130	Bhutani	1299	Cambodian	1489	Russian	1587	Volapük
1142	Greek	1300	Kannada	1491	Kinyarwanda	1613	Wolof
1144	English	1301	Korean	1495	Sanskrit	1632	Xhosa
1145	Esperanto	1305	Kashmiri	1498	Sindhi	1665	Yoruba
1149	Spanish	1307	Kurdish	1501	Sangho	1684	Chinese
1150	Estonian	1311	Kirghiz	1502	Serbo-Croatian	1697	Zulu
1151	Basque	1313	Latin	1503	Singhalese	1703	Not specified
1157	Persian	1326	Lingala	1505	Slovak		
1165	Finnish	1327	Laothian	1506	Slovenian		
1166	Fiji	1332	Lithuanian	1507	Samoan		
1171	Faroese	1334	Latvian; Lettish	1508	Shona		
1174	French	1345	Malagasy	1509	Somali		
1181	Frisian	1347	Maori	1511	Albanian		
1183	Irish	1349	Macedonian	1512	Serbian		

Parental Control area code list

Code	Area	Code	Area	Code	Area	Code	Area
2044	Argentina	2165	Finland	2362	Mexico	2149	Spain
2047	Australia	2174	France	2376	Netherlands	2499	Sweden
2046	Austria	2109	Germany	2390	New Zealand	2086	Switzerland
2057	Belgium	2248	India	2379	Norway	2528	Thailand
2070	Brazil	2238	Indonesia	2427	Pakistan	2184	United Kingdom
2079	Canada	2254	Italy	2424	Philippines		
2090	Chile	2276	Japan	2436	Portugal		
2092	China	2304	Korea	2489	Russia		
2115	Denmark	2363	Malaysia	2501	Singapore		

<http://www.sony.net/>



HDMI

 **Bluetooth®**

LDAC

DVD
VIDEO

COMPACT
disc
DIGITAL VIDEO

MP3



* 4 7 3 1 9 7 7 1 3 * (1)