

# *Portable CD/DVD Player*

Operating Instructions



*DVP-FX750*

## WARNING

To reduce the risk of fire or electric shock, do not expose this apparatus to rain or moisture.

To avoid electrical shock, do not open the cabinet. Refer servicing to qualified personnel only.

The mains lead must be changed only at a qualified service shop.

Batteries or batteries installed apparatus shall not be exposed to excessive heat such as sunshine, fire or the like.

## CAUTION

The use of optical instruments with this product will increase eye hazard. As the laser beam used in this CD/DVD player is harmful to eyes, do not attempt to disassemble the cabinet. Refer servicing to qualified personnel only.

Do not take apart or remodel the player. Doing so can result in electric shock. Consult your nearest Sony dealer or Sony Service Center for exchange of rechargeable batteries, internal checks or repair.

## Precautions

- Install this system so that the mains lead can be unplugged from the wall socket immediately in the event of trouble.
- The player is not disconnected from the AC power source (mains) as long as it is connected to the wall outlet, even if the player itself has been turned off.
- To prevent fire or shock hazard, do not place objects filled with liquids, such as vases, on the apparatus.
- Excessive sound pressure from earphones and headphones can cause hearing loss.

## IMPORTANT NOTICE



Caution: This player is capable of holding a still video image or on-screen display image on your television screen indefinitely. If you leave the still video image or on-screen display image displayed on your TV for an extended period of time you risk permanent damage to your television screen. Plasma display panel televisions and projection televisions are susceptible to this.

If you have any questions or problems concerning your player, please consult your nearest Sony dealer.

## Copyrights, licensing and trademarks

- Manufactured under licence from Dolby Laboratories. Dolby and the double-D symbol are trademarks of Dolby Laboratories.
- "DVD+RW," "DVD-RW," "DVD+R," "DVD+R DL," "DVD-R," "DVD VIDEO," and "CD" logos are trademarks.
- MPEG Layer-3 audio coding technology and patents licensed from Fraunhofer IIS and Thomson.
- DivX<sup>®</sup>, DivX Certified<sup>®</sup> and associated logos are registered trademarks of DivX, Inc. and are used under license.
- THIS PRODUCT IS LICENSED UNDER THE MPEG-4 VISUAL PATENT PORTFOLIO LICENSE FOR THE PERSONAL AND NON-COMMERCIAL USE OF A CONSUMER FOR DECODING VIDEO IN COMPLIANCE WITH THE MPEG-4 VISUAL STANDARD ("MPEG-4 VIDEO") THAT WAS ENCODED BY A CONSUMER ENGAGED IN A PERSONAL AND NON-COMMERCIAL ACTIVITY AND/OR WAS OBTAINED FROM A VIDEO PROVIDER LICENSED BY MPEG LA TO PROVIDE MPEG-4 VIDEO. NO LICENSE IS GRANTED OR SHALL BE IMPLIED FOR ANY OTHER USE. ADDITIONAL INFORMATION INCLUDING THAT RELATING TO PROMOTIONAL, INTERNAL AND COMMERCIAL USES AND LICENSING MAY BE OBTAINED FROM MPEG LA, LLC. SEE [HTTP://WWW.MPEGLA.COM](http://WWW.MPEGLA.COM)

## About this manual

- In this manual, “disc” is used as a general reference for the DVDs or CDs unless otherwise specified by the text or illustrations.
- Icons, such as  , listed at the top of each explanation indicate what kind of media can be used with the function being explained.  
For details, see “Playable Media” (page 27).
- NEED-to-know information (to prevent incorrect operation) is listed under the  icon.  
NICE-to-know information (tips and other useful information) is listed under the  icon.

# Table of Contents

WARNING .....	2
Guide to Parts and Controls .....	5
<hr/>	
<b>Preparations .....</b>	<b>9</b>
Checking the Accessories .....	9
Charging the Rechargeable Battery .....	9
Using the Car Battery Adaptor .....	10
Connecting to a TV .....	11
<hr/>	
<b>Playback .....</b>	<b>12</b>
Playing Discs .....	12
Playing MP3, JPEG, and Video Files .....	15
Adjusting the Picture Size and Quality .....	17
<hr/>	
<b>Settings and Adjustments .....</b>	<b>18</b>
Using the Setup Display .....	18
<hr/>	
<b>Additional Information .....</b>	<b>22</b>
Troubleshooting .....	22
Precautions .....	24
Playable Media .....	27
Specifications .....	29
Index .....	30

# Guide to Parts and Controls

For more information, see the pages indicated in parentheses.

## Player

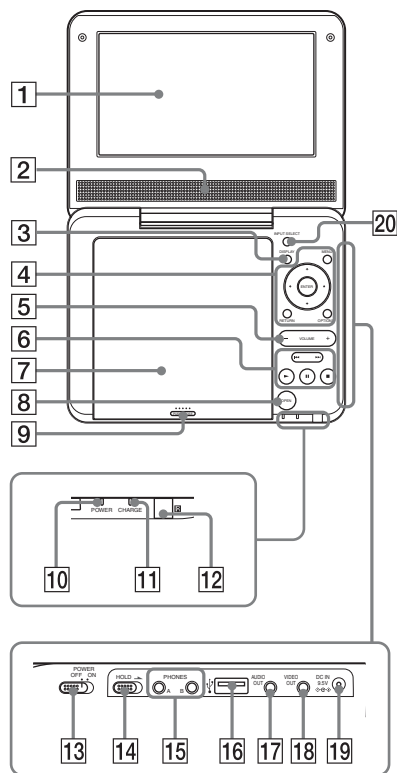

The VOLUME+ and ► (play) buttons have a tactile dot. Use the tactile dot as a reference when operating the player.

### 1 LCD panel (page 12)

### 2 Speaker

### 3 DISPLAY button

Displays the playback information.

- When playing a DVD: Displays the playback information and changes the playback mode. See page 14.
- When playing a CD: Each time you press the button, switches between track playback time and disc playback time.
- When playing a VIDEO CD: Displays the playback information.
- When playing a video file: Displays the playback information and changes the internal subtitle for DivX video files. To change the internal subtitle, press **↑/↓** and ENTER while displaying the subtitle information.

### 4 MENU button

- When playing a DVD VIDEO: Displays the menu.
- When playing a CD or VIDEO CD: Each time you press the button, switches Repeat Play, Shuffle Play, and Play. (Only when “PBC” is set to “Off” for VIDEO CD.)
- When playing a JPEG file: Displays the list of thumbnails and plays a slideshow. See page 15.

### ←/↑/↓/→ button

Moves the highlight to select a displayed item.

- When playing a DVD or VIDEO CD: **←/→** on the player works as the same as **◀▶** on the remote.

## Centre button (ENTER)

Enters the selected item.

- When playing a DVD or CD or VIDEO CD: ENTER on the player works as the same as .

## RETURN button

Returns to the previous display.

## OPTIONS button

Displays the menu for adjusting the LCD screen (page 17) and using the setup display (page 18).

---

## 5 VOLUME (sound volume) +/- button

Adjusts the volume.

---

## 6 (play) button (page 12)

Starts or re-starts playback.

## || (pause) button (page 12)

Pauses or re-starts playback.

## ■ (stop) button (page 12)

Stops playback.

## ◀◀ (previous)/▶▶ (next) button

Skips to the beginning of the current/next chapter, track or file.

To go to the beginning of the previous chapter/track/scene, press twice.

---

## 7 Disc Lid (page 12)

---

## 8 OPEN button (page 12)

Opens the disc lid.

---

## 9 PUSH CLOSE (page 12)

Closes the disc lid.

---

## 10 POWER indicator (page 12)

---

## 11 CHARGE indicator (page 9)

---

## 12 (remote sensor)

When operating by the remote, point it at the remote sensor .

---

## 13 POWER switch (page 12)

Turns the player on or off.

---

## 14 HOLD switch

To avoid accidental button operation of the player, set the HOLD switch to the direction of the arrow.

All the buttons on the player are locked, while the buttons on the remote remain operable.

---

## 15 PHONES (headphone) jack A, B

---

## 16 USB jack (type A) (page 16)

Connect a USB device to this jack.

---

## 17 AUDIO OUT jack (page 11)

---

## 18 VIDEO OUT jack (page 11)

---

## 19 DC IN 9.5V jack (page 9, 10)

Connect the AC power adaptor or car battery adaptor.

---

## 20 INPUT SELECT button (page 16)

Each time you press the button, the LCD screen image switches as follows:

- Disc mode (default): When playing an inserted disc.
- USB mode: When playing DATA files on a connected USB device. Appears “USB” on the LCD screen when you select this mode.

## Remote

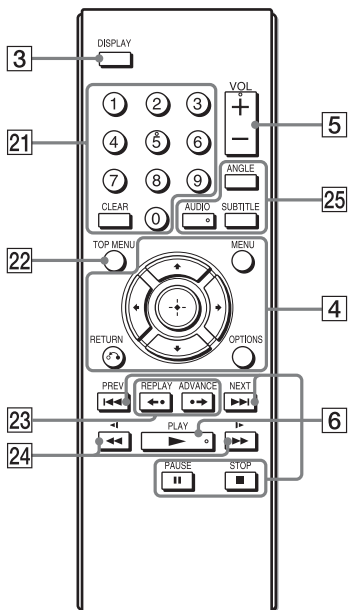

The VOL +, number 5, ► and AUDIO buttons have a tactile dot. Use the tactile dot as a reference when operating the player.

### 21 Number buttons

- Enters the title/chapter numbers, etc.
- When playing a DVD VIDEO or CD or VIDEO CD: Search directly by entering the title/chapter/track number using the number buttons, and press ENTER. (Only when “PBC” is set to “Off” for VIDEO CD.)
- To switch a title or chapter, press ←/→.

### CLEAR button

Clears the entry field.

### 22 TOP MENU button

Displays the menu or changes the playback mode.

- When playing a DVD VIDEO: Displays the top menu.
- When playing a DVD VR: Switches between “Original” and “Play List” on the disc created Playlist. During playback, you cannot switch. Press ■ twice, and press TOP MENU.

### 23 ◀◀REPLAY/▶▶ADVANCE buttons

Replays the scene/briefly fast forwards the current scene (DVD and DivX video files only).

### 24 ◀◀◀◀/▶▶▶▶ (scan/slow) buttons

- Fast reverses/ fast forwards when pressed during playback. Press repeatedly to change the speed.
- When playing a DVD: Slow reverses/ slow forwards when pressed during pause. Press repeatedly to change the speed.
  - When playing a VIDEO CD or video file: Slow forwards when pressed during pause. Press repeatedly to change the speed.

Depending on the disc, reverse slow playback may not be possible, or images may not appear smooth.

### 25 ANGLE button

Changes the angle. When “◻◻” (Angle Mark) appears, you can change angles. Depending on the disc, you may not be able to change the angle. (DVD VIDEO only)

## **AUDIO button**

Changes the audio signal.

- When playing a DVD VIDEO: Each time you press the button, the language of the sound track switches. Depending on the disc, the choice of language varies.
- When playing a DVD VR: Each time you press the button, the type of sound tracks recorded on a disc switches among main, sub and main/sub sound.
- When playing a CD or VIDEO CD: Each time you press the button, the mode switches between stereo and monaural (left/right).
- When playing a DivX video file: Each time you press the button, the audio signal switches. If “No Audio” appears, the player does not support the audio signal.

## **SUBTITLE button**

Changes the subtitle.

- When playing a DVD: Each time you press the button, the subtitle switches. Depending on the disc, the choice of language varies.
- When playing a DivX video file: Press the button to change the internal subtitle during playback. Press **↑/↓** and **ENTER** while displaying subtitle information.



## Checking the Accessories

Check that you have the following items:

- AC power adaptor (1)
- Car battery adaptor (1)
- Audio/video cord (mini plug × 2 ↔ phono plug × 3) (1)
- Remote (1)
- R6 (size AA) batteries (2)

### Preparing the remote

Insert two R6 (size AA) batteries by matching the ⊕ and ⊖ ends on the batteries to the markings inside the compartment.

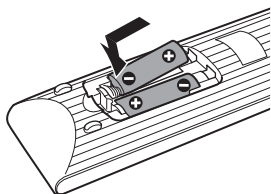

## Charging the Rechargeable Battery

Charge the rechargeable battery before using the player for the first time, or when the battery is depleted.

### 1 Connect the AC power adaptor.

When charging begins, the CHARGE indicator lights up in orange.

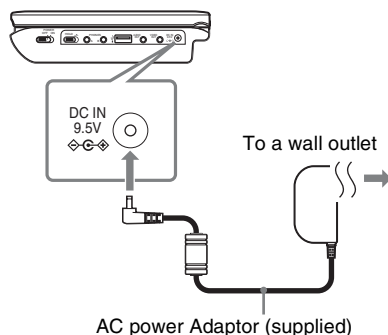

When charging ends, the CHARGE indicator lights off.

Disconnect the AC power adaptor.



If the POWER indicator lights up instead of the CHARGE indicator, the POWER switch is set to “ON.” Set the POWER switch to “OFF,” and make sure that the CHARGE indicator lights up.



Charge the battery in an ambient temperature of between 5°C to 35°C.

## Charging time and playing time

Charging time: approx. 3 hours

Playing time: approx. 3 hours

Times indicated are under the following conditions:

– Moderate temperature (20°C)

– Headphone use

– Backlight set to minimum

Depending on the ambient temperature or rechargeable battery condition, charging time may be longer, or playing time may be reduced.

## To check the battery level

When the player is stopped, the battery indicator is displayed. When the battery is empty,  is displayed or the CHARGE indicator flashes. Set the POWER switch to “OFF,” connect the AC power adaptor, and recharge the battery.



## Using the Car Battery Adaptor

The car battery adaptor (supplied) is for a 12V car battery, negative earth (do not use it with a 24V car battery, positive earth).

**1 Start the engine.**

**2 Connect the car battery adaptor.**

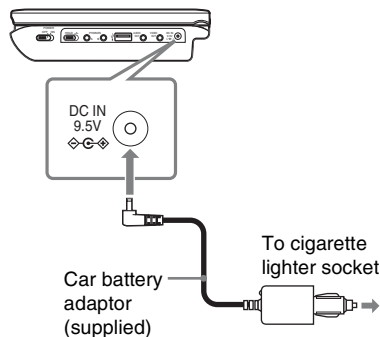

**3 Turn on the player.**



- The driver should not connect or disconnect the car battery adaptor while driving.
- Arrange the cord so as not to interfere with the driver. Also, do not place the LCD panel where the driver can watch.
- Clean the cigarette lighter socket. If it is dirty, it may cause contact failure or malfunction.
- Use the car battery adaptor with the car engine running. If it is used with the car engine off, the car battery may become depleted.

## After using the player in a car

- 1 Turn off the player.
- 2 Disconnect the car battery adaptor.
- 3 Turn off the engine.



- Do not disconnect the car battery adaptor or turn off the car engine before you turn off the player. Doing so may damage the player.
- Disconnect the car battery adaptor after use. If it is left connected, the car battery may become depleted.
- Do not leave the player or accessories in the car.

## Connecting to a TV

You can enjoy images on your TV or monitor by the following connection.

### 1 Connect the player to your TV or monitor using the audio/video cord (supplied).

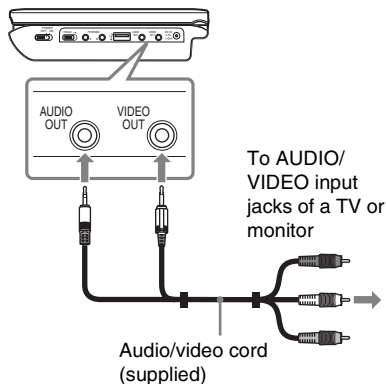

- When you play back a disc after enjoying images by "USB," press INPUT SELECT to select the disc mode. See page 6.
- The player can connect to an AV amplifier in the same way as a TV. Although connecting is the same as a TV, the yellow plug of the audio/video cord is not used.



- No picture is displayed on the LCD screen while connected to a TV using the audio/video cord.
- Refer to the instructions supplied with the equipment to be connected.
- Before connecting, turn off the player and the equipment to be connected, then unplug from their wall sockets.

## Playing Discs

DVDVideo DVDVR VCD CD

DATA

Depending on the disc, some operations may be different or restricted. Refer to the operating instructions supplied with the disc.

Connect the AC power adaptor.

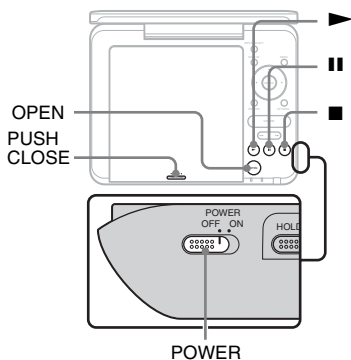

**1** Open the LCD panel.

**2** Slide the **POWER** switch to "ON."

The player turns on and the **POWER** indicator lights up in green.

**3** Press **OPEN** to open the disc lid.

**4** Insert the disc to be played.

Place with the playback side down and push gently until it clicks.

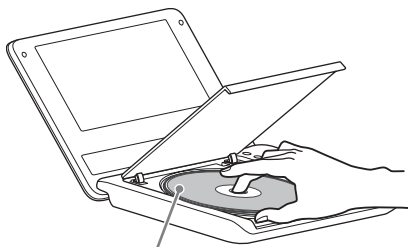

Playback side facing down

**5** Push the **PUSH CLOSE** on the disc lid to shut the disc lid.

**6** Press ▶.

The player starts playback.

Depending on the disc, a menu may appear. Press ←/↑/↓/→ to select the item, and press **ENTER**.

**To stop playback**

Press ■.

**To pause playback**

Press ||.



When you play back a disc after enjoying images by "USB," press **INPUT SELECT** to select the disc mode. See page 6.



- Discs created on DVD recorders must be correctly finalised to play on the player. For more information about finalising, refer to the operating instructions supplied with the DVD recorder.
- The disc may be still spinning when the disc lid is opened. Wait until the spinning stops before removing the disc.

## Notes on the screen saver

- A screen saver image appears when you leave the player in pause or stop mode without operation for more than 15 minutes. The image disappears when you press **▶**. For the setup of “Screen Saver,” see page 19.
- The player goes to standby, 15 minutes after starting the screen saver function. Press **▶** to come out of standby mode.

## To resume playback from the point where you stopped the disc (Resume Play)

**DVDVideo** **DVDVR** **VCD** **CD**

When you press **▶** again after you stop playback, the player starts playback from the point when you pressed **■**.



- To play from the beginning of the disc, press **■** twice, and press **▶**.
- When turning power on again after power off, resume play starts automatically.



- Depending on the stop point, Resume play may not start from exactly the same point.
- The resume point is cleared when:
  - you open the disc lid.
  - you press INPUT SELECT.

## To play VIDEO CDs with PBC Functions (PBC Playback)

**VCD**

PBC (Playback Control) allows you to play VIDEO CDs interactively using a menu. When you start playing a VIDEO CD with PBC functions, the menu appears. Select an item using the number buttons on the remote, and press ENTER. Then, follow the instructions in the menu (press **▶** when “Press SELECT.” appears).

## About various playback operations

To	Operation
Change the LCD picture size	Press <b>OPTIONS</b> to select “LCD Mode” (page 17).
Display the DVD menu	Press <b>MENU</b> (page 5) or <b>TOP MENU</b> (page 7).
Check the DVD playback information	Press <b>DISPLAY</b> (page 14).
Play DVDs* <sup>1</sup> repeatedly (Repeat Play)	Press <b>DISPLAY</b> to select “Repeat” (page 14).
Play DVDs in fast reverse or fast forward (Scan Play)	Press <b>◀/▶</b> repeatedly on the player to select the speed (page 5).
Switch between original and Playlist in DVD (VR mode)	Press <b>TOP MENU</b> repeatedly (page 7).
Check the CD or VIDEO CD playback information	Press <b>DISPLAY</b> (page 5).
Play CDs or VIDEO CDs* <sup>2</sup> repeatedly (Repeat Play)	Press <b>MENU</b> repeatedly (page 5).
Play CDs or VIDEO CDs* <sup>2</sup> randomly (Shuffle Play)	Press <b>MENU</b> repeatedly (page 5).
Play VIDEO CDs* <sup>2</sup> in fast reverse or fast forward (Scan Play)	Press <b>◀/▶</b> repeatedly on the player to select the speed (page 5).

\*<sup>1</sup> DVD VIDEO only

\*<sup>2</sup> only when “PBC” is set to “Off.”

## Using the Playback Information Display

DVDvideo DVDvr

While playing a DVD, you can check the current playback information. The playback information display also allows you to set a title/chapter or change sound/subtitle, and so on.

When entering the numbers, operate the number buttons on the remote.

### 1 Press DISPLAY while playing a DVD.

The current playback information appears.

Example: When playing a DVD VIDEO

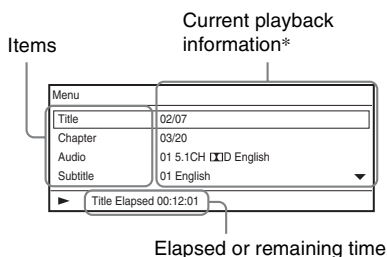

\* When a DVD (VR mode) is played, "PL" (playlist) or "ORG" (original) is displayed next to the title number.

### 2 Press $\uparrow/\downarrow$ to select items and press ENTER.

- Title: Select the title number by pressing  $\uparrow/\downarrow$  or number buttons.
- Chapter: Select the chapter number by pressing  $\uparrow/\downarrow$  or number buttons.
- Audio: Select the sound by pressing  $\uparrow/\downarrow$ .
- Subtitle: Select the subtitle by pressing  $\uparrow/\downarrow$ .
- Angle: Select the angle by pressing  $\uparrow/\downarrow$ .

- T.Time: Time appears while playing a title. "00:00:00" will appear by pressing ENTER. Enter the desired time code by pressing the number buttons.
- C.Time: Time appears while playing a chapter. "00:00:00" will appear by pressing ENTER. Enter the desired time code by pressing the number buttons.
- Repeat: Select " $\leftarrow$  Chapter," " $\leftarrow$  Title," " $\leftarrow$  All," or "Off" by pressing  $\uparrow/\downarrow$ .
- Time Disp.: "Title Elapsed" is displayed. Select "Title Elapsed," "Title Remain," "Chapter Elapsed," or "Chapter Remain" by pressing  $\uparrow/\downarrow$ .

### 3 Press ENTER.

#### To turn off the display

Press DISPLAY or RETURN.



Depending on the disc, you may not be able to set some items.

## Playing MP3, JPEG, and Video Files **DATA**

You can play MP3, JPEG, and video files. For details on playable files, see “Playable Media” (page 27).

When you set a DATA media, a list of albums appears.

DATA CDs recorded in KODAK Picture CD format automatically start playing when inserted.

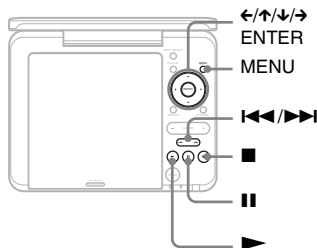

### 1 Press **↑/↓** to select the album, and press **ENTER**.

The list of files in the album appears. Example: The list of MP3 files

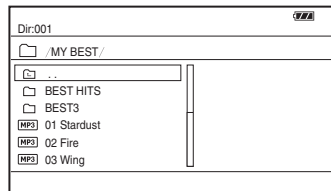

- To go to the next or previous page, press **▶▶** or **◀◀**.
- To return to the list of albums, press **↑/↓** to select **☰** and press **ENTER**.

### 2 Press **↑/↓** to select the file, and press **▶** or **ENTER**.

Playback starts from the selected file.

#### To go to the next or previous file

Press **▶▶** or **◀◀**.

#### To stop playback

Press **■**.



If the number of viewing times is preset, you can play the DivX video files as many times as the preset number. The following occurrences will be counted as one time:

- when **■** is pressed twice.
- when the player is turned off (including standby mode).
- when the disc lid is opened.
- when another file is played.
- when INPUT SELECT is pressed.
- when the USB device is disconnected.



Depending on the file, playback may take time to start or may not be able to start. For details on playable files, see “Playable Media” (page 27).

## Selecting a JPEG file

#### To rotate a JPEG image

Press **←/↑/↓/→** while viewing the image file. Rotate every file.

**→**: Rotates the image 90 degrees clockwise.

**←**: Rotates the image 90 degrees counter clockwise.

**↑/↓**: Reverses the image vertically (up and down).

#### To display the list of thumbnails

Press **MENU**.

The image files in the album appear in 12 sub-screens.

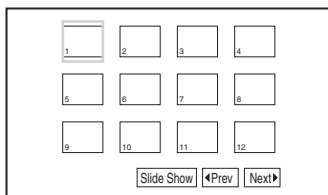

- To go to the previous or next list of thumbnails, select “◀Prev” or “Next▶” at the bottom of the screen, and press ENTER.
- To exit the list of thumbnails, press MENU.

---

## Playing a Slide Show

### 1 Press MENU.

The list of thumbnails appears.

### 2 Press ←/↑/↓/→ to select “Slide Show” at the bottom of the screen, and press ENTER.

A slideshow starts.

### To stop slideshow

Press ■ to return to the list of files.

Press MENU to return to the list of thumbnails.

### To pause slideshow

Press ■.

---

## Playing data on a USB device

You can playback DATA files on a USB device.

### 1 Press INPUT SELECT to select “USB.”

### 2 Connect a USB device to the USB jack.

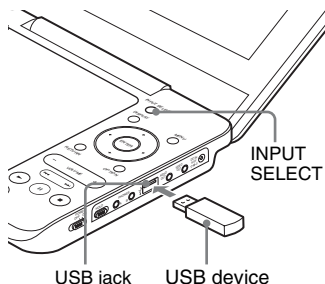

### To disconnect a USB device

- 1 Press INPUT SELECT to deselect “USB.”
- 2 Disconnect the USB device.

### About supported Sony USB devices

The following Sony USB Memory Stick reader/writer and USB flash drive “Micro Vault” are supported: MSAC-US40, USM-J series, USM-JX series, USM-J/B series, USM-L series, and USM-LX series.



- Some DivX files need more loading time by a USB device.
- Do not disconnect the USB device while its access indicator is flashing. Doing so may cause data corruption or loss of data.
- USB devices which can connect to the player are flash memory and multiple card readers. Other devices (digital still camera, USB hub, etc.) cannot be connected. When an unsupported device is connected, an error message appears.



# Adjusting the Picture Size and Quality

DVDVideo DVDVR VCD DATA

You can adjust the picture displayed on the LCD screen.

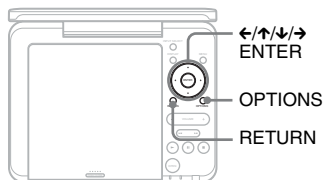

## 1 Press OPTIONS.

The menu display appears.

## 2 Press $\uparrow/\downarrow$ to select “LCD Mode” and press ENTER.

The “LCD Mode” display appears.

items

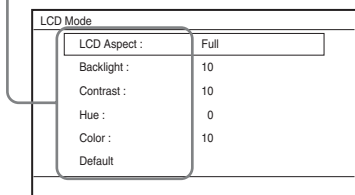

## 3 Press $\uparrow/\downarrow$ to select items and press ENTER.

- LCD Aspect: Change the picture size. Select “Normal,” “Full” or “Zoom” by pressing  $\uparrow/\downarrow$ \*.
- Backlight: Adjust the brightness by pressing  $\leftarrow/\rightarrow$ .
- Contrast: Adjust the difference between light and dark areas by pressing  $\leftarrow/\rightarrow$ .

- Hue: Adjust the red and green colour balance by pressing  $\leftarrow/\rightarrow$ .
- Color: Adjust the richness of colours by pressing  $\leftarrow/\rightarrow$ .
- Default: Return all settings to the factory defaults.

## 4 Press ENTER.

\* In “Normal,” pictures are displayed in their original configuration, retaining the aspect ratio. 4:3 pictures are displayed with black bands on both sides of the screen. 4:3 letter box pictures are displayed with bands on all sides of the screen.

In “Full,” pictures are adjusted to fill the entire screen. 16:9 pictures are displayed in their original configuration. (Black band recorded in a 16:9 picture cannot be erased.) 4:3 pictures appear stretched.

In “Zoom,” 4:3 pictures are displayed full width. The upper and lower areas of the picture will be slightly cut.

### To turn off the menu display

Press OPTIONS or RETURN twice.



Depending on the disc, the screen size you can select differs.

# Using the Setup Display

By using the setup display, you can make various settings to items such as picture and sound.

Some discs have stored playback settings, which take priority.

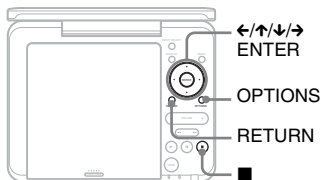

## 1 Press **OPTIONS** when the player is in stop mode.

The menu display appears. During Resume Play, you cannot use the setup display. Press ■ twice to clear Resume Play, and press **OPTIONS**.

## 2 Press **↑/↓** to select “Setup,” and press **ENTER**.

The setup display appears.

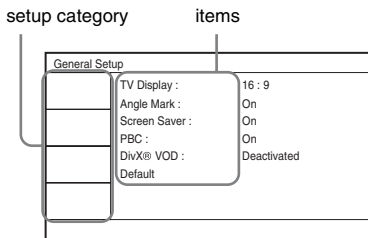

## 3 Press **↑/↓** to select the setup category and press **ENTER**.

: General Setup (page 18)  
Makes the player-related settings.

: Audio Setup (page 19)  
Makes the audio settings according to playback conditions.

: Language Setup (page 20)  
Makes the language settings for the on-screen display or sound track.

: Parental Control (page 20)  
Sets the parental control limit.

## 4 Select and adjust each of the following items by pressing **↑/↓** and **ENTER**.

### To turn off the setup display

Press **OPTIONS** or **RETURN** twice.

## General Setup

The default settings are underlined.

### ◆ TV Display

Selects the aspect ratio of the connected TV.

When you watch images on the LCD screen of this player, set “16:9” for “TV display” setting.

4:3 Pan Scan	Select this when you connect a 4:3 screen TV. Automatically displays a wide picture on the entire screen and cuts off the portions that do not fit.
4:3 Letter Box	Select this when you connect a 4:3 screen TV. Displays a wide picture with bands on the upper and lower portions of the screen.
<u>16:9</u>	Select this when you connect a wide-screen TV or a TV with a wide mode function.

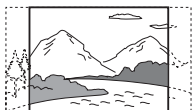
**4:3 Pan Scan****4:3 Letter Box****16:9**

Depending on the disc, “4:3 Letter Box” may be selected automatically instead of “4:3 Pan Scan” or vice versa.

### ◆ Angle Mark (DVD VIDEO only)

Displays the angle mark when you can change the viewing angles during playback of DVDs recorded with multi-angles.

<u>On</u>	Display the angle mark.
Off	Hide the angle mark.

### ◆ Screen Saver

The screen saver image appears when you leave the player in pause or stop mode for 15 minutes. The screen saver will help prevent your display equipment from becoming damaged (ghosting). Press **▶** to turn off the screen saver.

<u>On</u>	Activates the screen saver function.
Off	Deactivates the screen saver function.

### ◆ PBC

You can enjoy playing interactive programmes using the PBC (Playback Control) function of a VIDEO CD if available (page 13).

<u>On</u>	By the PBC function, you can play back VIDEO CDs via the menu screen.
Off	Turn off the PBC function.

### ◆ DivX® VOD

Displays the registration code and deactivation code for the player. For more information, go to <http://vod.divx.com> on the Internet.

### ◆ Default

Each function returns to its original factory settings. Note that all of your settings will be lost.

## 🔊 Audio Setup

The default setting is underlined.

### ◆ Audio DRC (Dynamic Range Control) (DVD only)

Makes the sound clear when the volume is turned down when playing a DVD that conforms to “Audio DRC.”

<u>Standard</u>	Standard sound.
<u>TV Mode</u>	Makes low sounds clear even if you turn the volume down.
Wide Range	Gives you the feeling of being at a live performance.

## Language Setup

### ◆ OSD (On-Screen Display)

Switches the display language on the screen.

### ◆ Disc Menu (DVD VIDEO only)

Switches the language for the disc's menu. When you select "Original," the language given priority in the disc is selected.

### ◆ Subtitle (DVD VIDEO only)

Switches the subtitle language. When you select "Off," no subtitle is displayed.

### ◆ Audio (DVD VIDEO only)

Switches the language of the sound track. When you select "Original," the language given priority in the disc is selected.

### ◆ DivX Subtitle

Selects the language to display the external subtitle of the DivX video file.

CP1250	Albanian, Bosnian, Croatian, Czech, English, German, Hungarian, Icelandic, Irish, Polish, Romanian, Slovak, Slovenian
CP1251	Bulgarian, Belarusian, English, Macedonian, Moldavian, Russian, Serbian, Ukrainian
CP1253	Greek
CP1254	Albanian, Danish, Dutch, English, Estonian, Finnish, French, Gaelic, German, Italian, Kurdish (Latin), Norwegian, Portuguese, Spanish, Swedish, Turkish



If you select a language in "Disc Menu," "Subtitle," or "Audio" that is not recorded on the disc, one of the recorded languages will be automatically selected.

## Parental Control



You can limit playback of a DVD that has the parental control function.

When you operate this setting, use the remote.

### ◆ Password (DVD VIDEO only)

Enter or change a password. Set the password for the parental control function. Enter your 4-digit password using the number buttons on the remote.

### To change the password

- 1 Press / to select "Password," and press ENTER.
- 2 Check "Change" is selected and press ENTER.  
The display for entering the password appears.

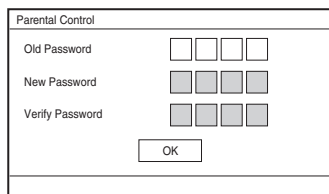

The image shows a screen titled "Parental Control" with three rows of input fields. The first row is labeled "Old Password" and has four empty boxes. The second row is labeled "New Password" and has four empty boxes. The third row is labeled "Verify Password" and has four empty boxes. Below the input fields is an "OK" button.

- 3 Enter your current password in "Old Password," your new password in "New Password" and "Verify Password," and press ENTER.

### If you make a mistake entering your password

Press CLEAR, or press  to return one by one before pressing ENTER in step 3, and re-enter the password.

### If you forget your password

Enter "1369" in "Old Password," and enter your new password in "New Password" and "Verify Password."

### ◆ Parental Control (DVD VIDEO only)

Set the limitation level. The lower the value, the stricter the limitation.

To set the parental control, you need to set the password first.

#### To set the parental control (limited playback)

- 1 Press **↑/↓** to select “Parental Control,” and press **ENTER**.
- 2 Press **↑/↓** to select the limitation level, and press **ENTER**. The lower the value, the stricter the limitation. The display for entering the password appears.

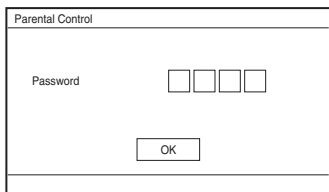

- 3 Enter your password, and press **ENTER**.

#### To play a disc for which Parental Control is set

Insert the disc and press **▶**. The display for entering your password appears. Enter your password using the number buttons on the remote, and press **ENTER**.



- When you play discs which do not have the Parental Control function, playback cannot be limited on the player.
- Depending on the disc, you may be asked to change the parental control level while playing the disc. In this case, enter your password, then change the level. If the Resume Play mode is cancelled, the level returns to the previous level.

## Troubleshooting

If you experience any of the following difficulties while using the player, use this troubleshooting guide to help remedy the problem before requesting repairs. Should any problem persist, consult your nearest Sony dealer.

### Power

#### The power is not turned on.

- ➔ Check that the AC power adaptor is connected securely (page 9).
- ➔ Check that the rechargeable battery is sufficiently charged (page 9).

#### The rechargeable battery cannot be charged.

- ➔ You cannot charge the rechargeable battery when power is turned on. Set the POWER switch to "OFF" (page 9).

### Picture

#### There is no picture/picture noise appears.

- ➔ The disc is dirty or flawed (page 26).
- ➔ The brightness is set at minimum. Adjust the brightness of the LCD (page 17).
- ➔ When "USB" is displayed, press INPUT SELECT (page 6).

#### The black points appear and the red, blue, green points remain on the LCD.

- ➔ This is a structural property of the LCD and not malfunction.

#### Black bands appear in the upper and lower areas when you play a 16:9 picture on the LCD screen.

- ➔ Set "16:9" for "TV Display" in "General Setup" (page 18).

### Sound

#### There is no sound.

- ➔ The player is in pause mode or in slow play mode.
- ➔ The player is in fast forward or fast reverse mode.

#### The sound volume is low.

- ➔ The sound volume is low on some DVDs. The sound volume may improve if you set "Audio DRC" in "Audio Setup" to "TV Mode" (page 19).

### Operation

#### Nothing happens when buttons are pressed.

- ➔ The HOLD switch is set in the direction of the arrow (page 6).

#### The disc does not play.

- ➔ If the disc is turned over, a "No Disc" or "Cannot play this disc." message appears. Insert the disc with the playback side facing down (page 12).
- ➔ The disc is not set until it clicks (page 12).
- ➔ The disc that cannot be played is inserted. Check the region code matches the player, and that the disc has been finalised (page 27).
- ➔ When "USB" is displayed, press INPUT SELECT (page 6).
- ➔ Parental Control has been set. Change the setting (page 20).
- ➔ Moisture has condensed inside the player (page 25).

---

### The player starts and stops playing the disc automatically.

- ➔ The disc features an auto playback function.
- ➔ While playing discs with an auto pause signal, the player stops playback at the auto pause signal.

---

### The disc does not start playing from the beginning.

- ➔ Repeat Play or Shuffle Play is selected (page 13).
- ➔ Resume play has taken effect (page 13).
- ➔ The Playlist of the created disc is automatically played. To play original titles, press TOP MENU to set “Original” (page 7).

---

### Playback may take time to start.

- ➔ Playback may take time to start in DVD (VR mode).

---

### Playback freezes.

- ➔ When the playback layer of a DVD+R DL/-R DL disc changes, playback may freeze.

---

### The subtitles disappear.

- ➔ When you change playback speed, or skip scenes during playback, the subtitles may disappear temporarily.

---

### “Ⓞ” appears.

- ➔ Playback of the file is not supported.

---

### “Copyright lock” appears and the screen turns blue when playing a DVD (VR mode) disc.

- ➔ Images taken from digital broadcasts, etc., may contain copy protection signals, such as complete copy protection signals, single copy signals, and restriction-free signals. When images that contain copy protection signals are played, a blue screen may appear instead of the images.

It may take a while when looking for playable images. (For player that cannot play images that contain a copy protection only.)

---

### ⏪/⏩ does not work on menu display.

- ➔ Depending on the disc, you may not be able to use ⏪/⏩ on the player for the disc menu. In this case, use ⏪/⏩ on the remote.

---

### The remote does not function.

- ➔ Batteries in the remote are weak.
- ➔ There are obstacles between the remote and the player.
- ➔ The distance between the remote and the player is too far.
- ➔ The remote is not pointed at the remote sensor on the player.
- ➔ Direct sunlight or strong illumination is striking the remote sensor.
- ➔ When the AUDIO/SUBTITLE/ANGLE buttons do not work, select and operate it from the DVD menu.

---

### The MP3, JPEG, or video file cannot be played (page 28).

- ➔ The file format does not conform.
- ➔ The extension does not conform.
- ➔ The file is damaged.
- ➔ The file size is too large.
- ➔ When the selected file is not supported, “Not Support” appears and the file will not be played.
- ➔ Because of the compression technology used for DivX/MPEG-4 video files, playback may take time to start.

---

### The file or album names are not displayed correctly.

- ➔ The player can only display numbers and alphabet. Other characters are displayed as “\*” (page 28).

---

**The player does not operate properly or the power does not turn off.**

- ➔ When static electricity, etc., causes the player to operate abnormally, turn off the power and leave for ten seconds.

---

**Hookup****There is no picture or sound on the connected equipment.**

- ➔ Re-connect the connecting cord securely (page 11).
- ➔ The connecting cord is damaged.
- ➔ Check the setting of a connected TV or amplifier.
- ➔ When “USB” is displayed, press INPUT SELECT (page 6).

---

**USB****The player does not recognize a USB device connected to the player.**

- ➔ Re-connect the USB device securely (page 16).
- ➔ The USB device is damaged.
- ➔ Press INPUT SELECT to select “USB” (page 16).

---

**Precautions****Road safety**

Do not use the monitor unit and headphones while driving, cycling, or operating any motorized vehicle. Doing so may create a traffic hazard and is illegal in some areas. It can also be potentially dangerous to play your headsets at high volume while walking, especially at pedestrian crossings. You should exercise extreme caution or discontinue use in potentially hazardous situations.

**On safety**

Should any solid object or liquid fall into the cabinet, unplug the player and have it checked by qualified personnel before operating it any further.

**On power sources**

- If you are not going to use the player for a long time, be sure to disconnect the player from the wall outlet. To disconnect the AC power adaptor, grasp the plug itself; never pull the cord.
- Do not touch the AC power adaptor with wet hands. Doing so may cause shock hazard.
- Do not connect the AC power adaptor to a traveler’s electric transformer, which may generate heat and cause a malfunction.

**On temperature increases**

Heat may build up inside the player during charging or if it is being used for a long time. This is not a malfunction.



## On placement

- Do not place the player in a confined space such as a bookshelf or similar unit.
- Do not cover the ventilation of the player with newspapers, tablecloths, curtains, etc. And do not place the player on a soft surface, such as a rug.
- Do not place the player and adaptors in a location near heat sources, or in a place subject to direct sunlight, excessive dust, sand, moisture, rain, or mechanical shock, or in a car with its windows closed.
- Do not place the player in an inclined position. It is designed to be operated in a horizontal position only.
- Keep the player and discs away from equipment with strong magnet, such as microwave ovens, or large loudspeakers.
- Do not drop or apply strong shock. Do not place heavy objects on the player and accessories.

## On operation

- If the player is brought directly from a cold to a warm location, or is placed in a very damp room, moisture may condense on the lenses inside the player. Should this occur, the player may not operate properly. In this case, remove the disc and leave the player for about half an hour until the moisture evaporates. Wipe off moisture attached to the LCD surface with tissue etc. Turn on the power again later.
- Keep the lens on the player clean and do not touch it. Touching the lens may damage the lens and cause the player to malfunction. Leave the disc lid closed except when you insert or remove discs.
- Turn off the power before disconnecting the AC power adaptor, the car battery adaptor. Failure to do so may cause a malfunction.

## On Liquid Crystal Display

- Although manufactured with high precision technology, the LCD may occasionally display dots of various colours. That is not a malfunction.
- Do not place or drop any object onto the LCD surface. Also, do not apply pressure from hands or elbows.
- Do not damage the LCD surface with a sharp edged tool.

## On rechargeable battery

- Certain countries may regulate disposal of the battery used to power this product. Please consult with your local authority.
- Because of the battery's limited life, its capacity gradually deteriorates over time and repeated use. Exchange a new one when the battery holds about only half the normal period.
- The battery may not be charged to its fullest capacity when charged for the first time, or when it has not been used for a long time. The capacity recovers after being charged and discharged several times.

## On AC power adaptor and car battery adaptor

- Use the supplied adaptors for the player, as other adaptors may cause a malfunction.
- Do not disassemble or reverse-engineer.
- Do not touch the metal parts, as it may cause a short and damage the adaptors, especially if touched by other metal objects.

## On adjusting volume

Do not turn up the volume while listening to a section with very low level inputs or no audio signals. If you do, the speakers may be damaged when a peak level section is played.

## On headphones

- Preventing hearing damage: Avoid using headphones at high volumes. Hearing experts advice against continuous, loud, and extended play. If you experience a ringing in your ears, reduce the volume or discontinue use.
- Showing consideration for others: Keep the volume at a moderate level. This will allow you to hear outside sounds and still be considerate to the people around you.

## On cleaning

- Clean the cabinet, panel, and controls with a soft cloth slightly moistened with a mild detergent solution. Do not use any type of abrasive pad, scouring powder or solvent such as alcohol or benzine.
- Wipe the LCD surface with the soft dry cloth lightly. To prevent dirt buildup, wipe it frequently. Do not wipe the LCD surface with a wet cloth. If water enters, a malfunction may result.
- If picture/sound is distorted, the lens may be covered with dust. In this case, use a commercially-available blower brush for camera lenses to clean the lens. Avoid touching the lens directly during cleaning.

## On cleaning discs, disc/lens cleaners

Do not use cleaning discs or disc/lens cleaners (including wet or spray types). These may cause the apparatus to malfunction.

## Notes About the Discs

- To keep the disc clean, handle the disc by its edge. Do not touch the surface.















- Do not expose the disc to direct sunlight or heat sources such as hot air ducts, or leave it in a car parked in direct sunlight as the temperature may rise considerably inside the car.
- After playing, store the disc in its case.
- Clean the disc with a cleaning cloth. Wipe the disc from the centre out.



- Do not use solvents such as benzine, thinner, disc/lens cleaners, or anti-static spray intended for vinyl LPs.
- If you have printed the disc's label, dry the label before playing.
- Do not use the following discs:
  - A disc that has a non-standard shape (e.g., card, heart).
  - A disc with a label or sticker on it.
  - A disc that has cellophane tape or sticker adhesive on it.

# Playable Media

Type	Disc Logo	Icon	Characteristics
DVD	     <small>DVD+ReWritable      DVD+R</small>		<ul style="list-style-type: none"> <li>• Commercial DVD</li> <li>• DVD+RWs/DVD+Rs/ DVD+R DLs in +VR mode</li> <li>• DVD-RWs/DVD-Rs/ DVD-R DLs in video mode</li> </ul>
	 <small>DVD+R DL</small>		DVD-RWs/DVD-Rs/DVD-R DLs in VR (Video Recording) mode
CD			<ul style="list-style-type: none"> <li>• Music CDs</li> <li>• CD-Rs/CD-RWs in music CD format</li> </ul>
			<ul style="list-style-type: none"> <li>• VIDEO CDs containing Super VCDs</li> <li>• CD-Rs/CD-RWs in video CD format or Super VCD format</li> </ul>
DATA disc or USB	—		DATA CD/DATA DVD or USB devices containing MP3, JPEG, or video files.



## Notes about recordable media

Some recordable media cannot be played on the player due to the recording quality or physical condition of the media, or the characteristics of the recording device and authoring software.

**The disc will not play if it has not been correctly finalised.** For more information, refer to the operating instructions for the recording device. Note that some playback functions may not work with some DVD+RWs/+Rs/+R DLs, even if they have been correctly finalised. In this case, view the disc by normal playback.

## For player that cannot play images that contain a copy protection only

Images in DVD (VR mode) with CPRM\* protection may not be played if they contain a copy protection signal. "Copyright lock" appears.

\* CPRM (Content Protection for Recordable Media) is a coding technology that protects the copyright of images.

---

## Notes on MP3, JPEG, and video files

The player can play the following files:

- MP3 files with the extension “.mp3”<sup>\*1</sup>.
- JPEG files with the extension “.jpg”<sup>\*2</sup>.
- JPEG image files that conform to the DCF (Design rule for Camera File system) image file format.
- DivX video files with the extension “.avi” or “.divx.”
- MPEG-4 video files (simple profile) with the extension “.mp4”<sup>\*3</sup>.
- DATA CDs must be recorded according to ISO 9660 Level 1, or its extended format, Joliet.
- DATA DVDs must be recorded according to UDF (Universal Disk Format).

<sup>\*1</sup> Files in mp3PRO format cannot be played.

<sup>\*2</sup> Files with the extension “.jpe” or “.jpeg” can be played by changing the extension to “.jpg.”

<sup>\*3</sup> Files with copyright protection (Digital Right Management) cannot be played. Files in MPEG-4 AVC format cannot be played.



- To play a complex hierarchy of folders may take some time. Create albums as follows:
  - The number of hierarchies in the media should be no more than two.
  - The number of albums in the media should be 50 or less.
  - The number of files in one album should be 100 or less.
  - The total number of albums and files in the media should be 800 or less.
- The player plays the file in an album in the order the media was recorded.



- The player will play any file in the above table, even if the file format differs. Playing such data may generate noise that can result in speaker damage.
- Some DATA discs created in Packet Write format cannot be played.
- Some DATA discs created in multiple sessions may not be playable.

- Some JPEG files cannot be played.
- The player cannot play the JPEG file that is larger than 3078 (width) × 2048 (height) in normal mode, or larger than 2000 (width) × 1200 (height) in progressive JPEG. (Some progressive JPEG files cannot be displayed even if the size is within this specified capacity.)
- Some MPEG-4 video files cannot be played.
- The player may not play a combination of two or more DivX/MPEG-4 video files.
- The player cannot play a DivX/MPEG-4 video file of size more than 720 (width) × 576 (height)/2 GB.
- The player may not play certain DivX/MPEG-4 video files that are longer than 3 hours.
- Depending on the DivX/MPEG-4 video file, normal playback may not be possible. The picture may be unclear, playback may not appear smooth, the sound may skip, etc. You are recommended to create the file at a lower bit rate. If the sound is still noisy, check the audio format. (MP3 is recommended for DivX video files, and MPEG-4 video file should be AAC LC.) Note, however, the player does not conform to WMA (Windows Media Audio) format.
- The player may not playback the high bit rate video file on the DATA CD smoothly. You are recommended to playback using DATA DVD.
- Names of files or albums may not be fully displayed if they are too long. Special character appears as “\*.”
- The player can display only the currently playing album name. Any album located on the upper layer is displayed as “/./.”
- Playback information of some files may not be displayed correctly.

## Notes on commercial discs

### Region code

It is the system that is used to protect copyrights. The region code is shown on the DVD VIDEO packages according to the region of sale. DVD VIDEOS labelled “ALL” or “3” will play on the player.



### DVD and VIDEO CD playback operations

Some playback operations of DVDs and VIDEO CDs may be intentionally set by software producers. Since the player plays DVDs and VIDEO CDs according to the disc contents the software producers designed, some playback features may not be available. Also, refer to the instructions supplied with the DVDs and VIDEO CDs.

### Notes on discs

This product is designed to playback discs that conform to the Compact Disc (CD) standard. DualDiscs and some music discs encoded with copyright protection technologies do not conform to the Compact Disc (CD) standard. Therefore, these discs may not be compatible with this product.

## Specifications

### System

**Laser:** Semiconductor laser

**Signal format system:** PAL (NTSC)

### Outputs

**VIDEO (video output):**

Minijack

**AUDIO (audio output)**

Stereo minijack

**PHONES (headphones) A/B:**

Stereo minijack

**USB:**

USB jack Type A (For connecting USB memory)

### Liquid Crystal Display

**Panel size (approx.):** 18 cm/7 inches wide (diagonal)

**Driving system:** TFT active matrix

**Resolution:** 480 × 234 (effective pixel rate: more than 99.99%)

### General

**Power requirements:**

DC 9.5 V (AC power Adaptor/Car battery adaptor)

DC 7.4 V (rechargeable battery)

**Power consumption (DVD VIDEO Playback):**

6.5 W (when used with a headphone)

**Dimensions (approx.):**

200 × 42.4 × 155 mm (width/height/depth) incl. projecting parts

**Mass (approx.):** 860 g

**Operating temperature:** 5 °C to 35 °C

**Operating humidity:** 25 % to 80 %

**AC Power Adaptor:** 110-240 V AC, 50/60 Hz

**Car Battery Adaptor:** 12 V DC

### Supplied accessories

See page 9.

Specifications and design are subject to change without notice.

---

# Index

## Numerics

- 16:9 18
- 4:3 Letter Box 18
- 4:3 Pan Scan 18

## A

- Angle Mark 7, 19
- Audio 7, 20
- Audio DRC 19
- Audio Setup 19

## C

- CD 12, 27
- Charging time and playing time 10

## D

- DATA 15, 27
- Disc Menu 20
- DivX (video file) 15, 28
- DVD 12, 27

## G

- General Setup 18

## J

- JPEG 15, 28

## L

- Language Setup 20
- LCD Aspect 17
- LCD Mode 17

## M

- MP3 15, 28
- MPEG-4 (video file) 15, 28

## O

- OSD (On-Screen Display) 20

## P

- Parental Control 20
- Password 20
- PBC 13, 19
- Playable Media 27
- Playback Information Display 14

## R

- Region code 29
- Repeat Play 13
- Resume Play 13

## S

- Screen Saver 13, 19
- Setup 18
- Shuffle Play 13
- Slide Show 16
- Subtitle 8, 20

## T

- Troubleshooting 22
- TV Display 18

## U

- USB 16

## V

- VIDEO CD 12, 27
- Video file (DivX/MPEG-4) 15, 28



4-169-964-42(1)



\* 1 - 4 1 6 9 9 6 4 4 2 D \*