



Quick Setup Guide/快速設定指南

DAV-FZ900KW

1 Connecting the speakers/連接揚聲器

Connect the speaker cords to match the color of the SPEAKER jacks of the unit.

將揚聲器導線連接到本機上對應顏色的 SPEAKER 插孔。

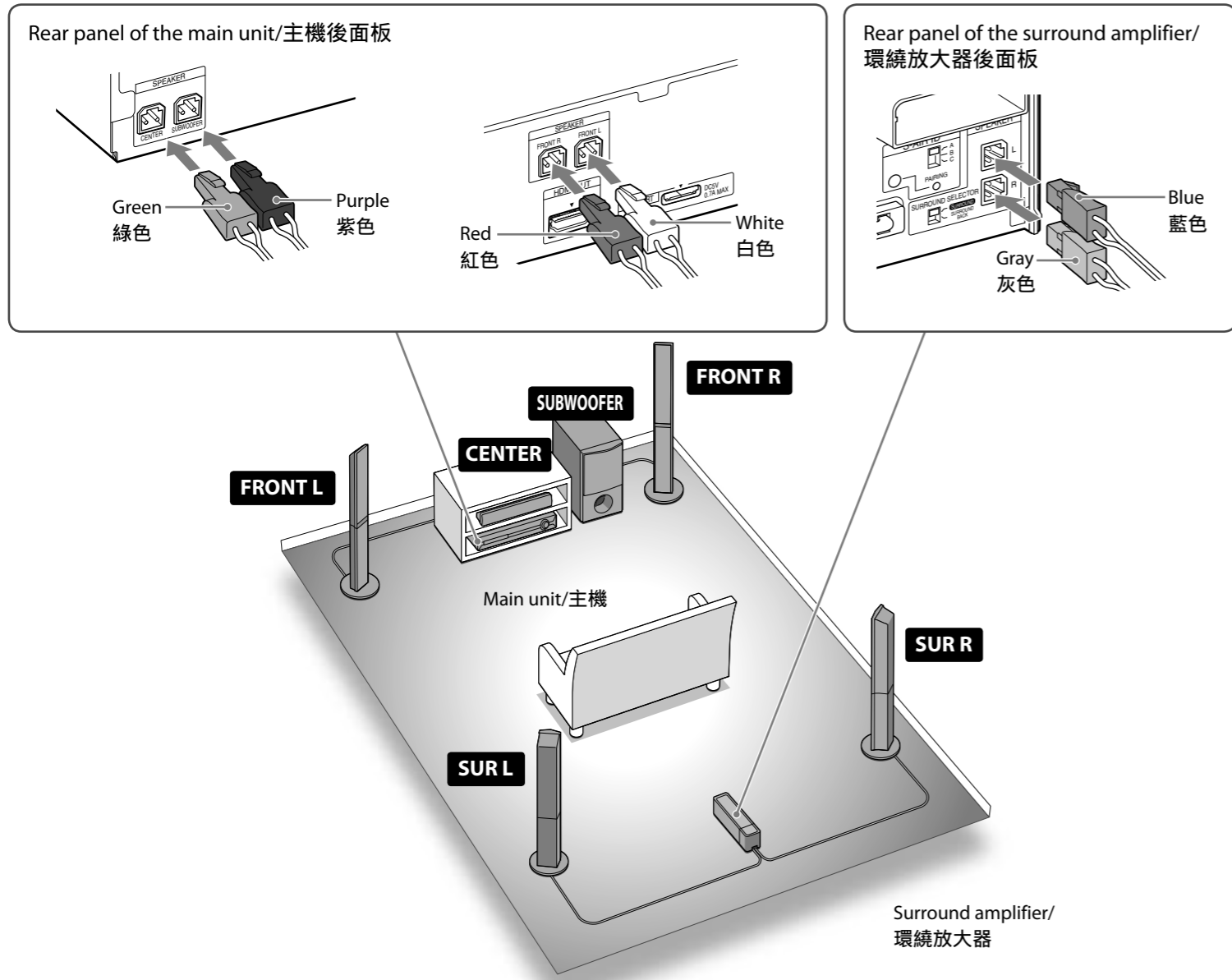

To connect speaker cords to the speaker/將揚聲器導線連接到揚聲器

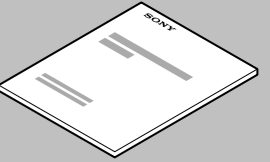
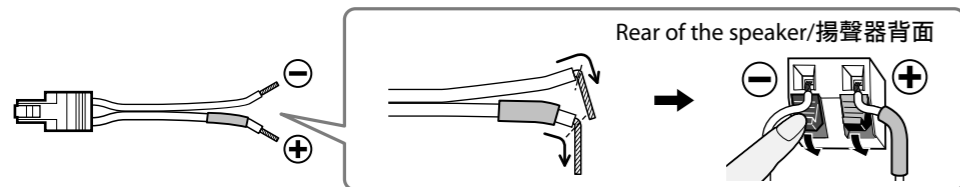

For details, see the Operating Instructions.
詳細說明請參閱使用說明書。

2 Connecting the TV/連接電視機

Depending on the jacks on your TV, select the video and audio connection method.
視電視機上的插孔而定，選擇視頻和聲音的連接方法。

Video connection method/視頻連接方法

Method 1/方法 1

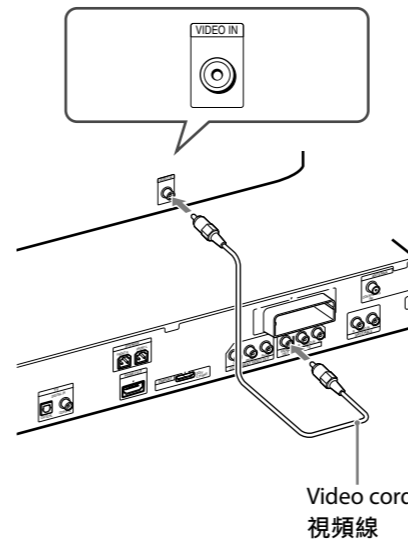

Method 2/方法 2

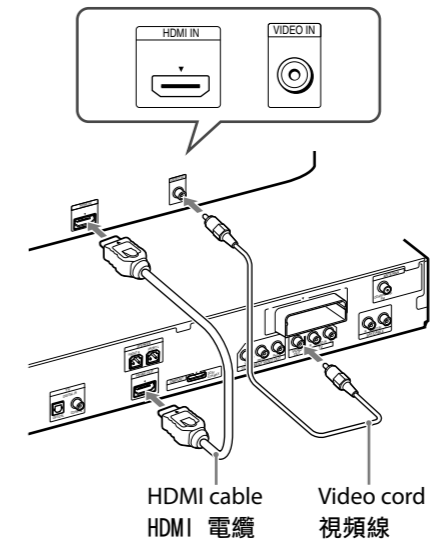

Method 3/方法 3

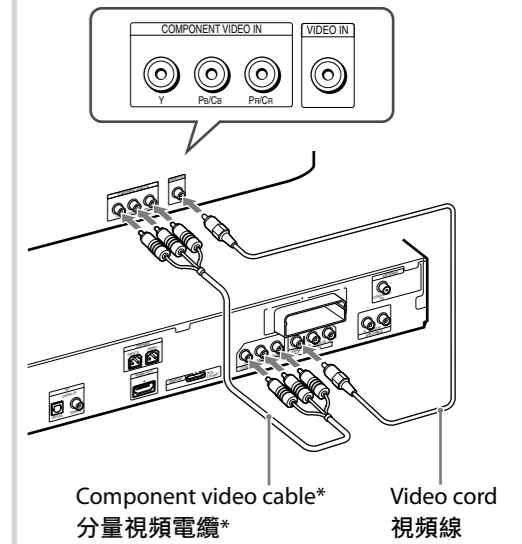

*Not supplied/不提供

Audio connection method/聲音連接方法

Method 1/方法 1

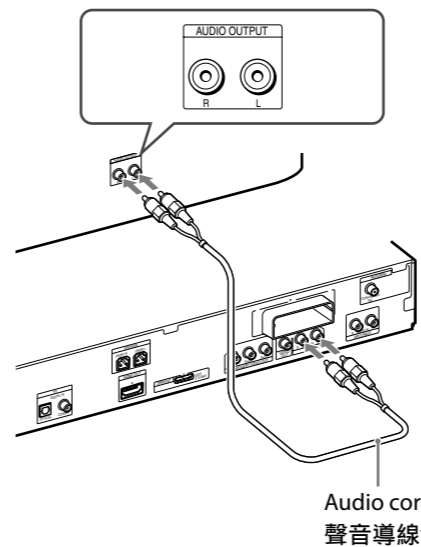

Method 2/方法 2

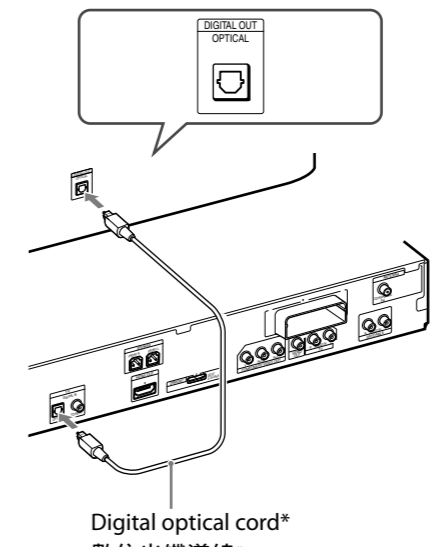

Method 3/方法 3

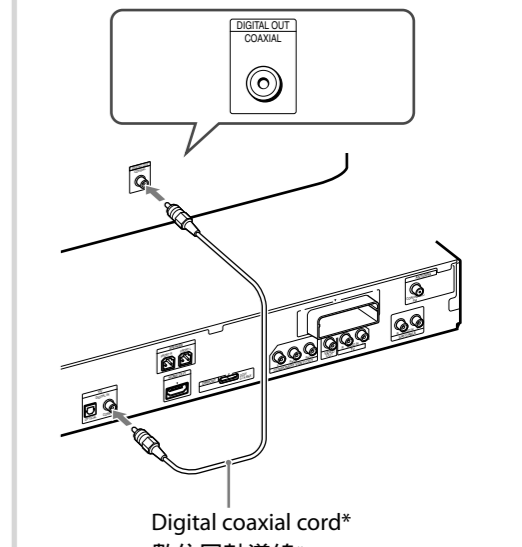

*Not supplied/不提供

3 Enabling wireless transmission/ 啓用無線傳送

- 1 Insert the wireless transceiver.**
裝入無線收發器。

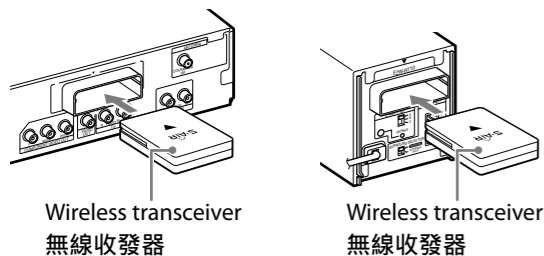

- 2 Set the S-AIR ID switch to "A."**
將 S-AIR ID 開關設定為 "A"。

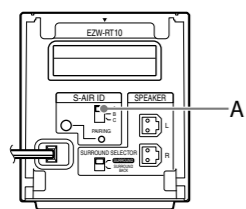

- 3 Connect the AC power cord.**
連接交流電源線。

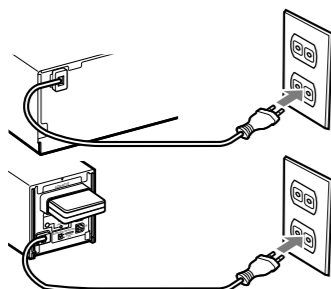

- 4 Turn on the power of the main unit, the surround amplifier, and the TV.**
打開主機、環繞放大器和電視機的電源。

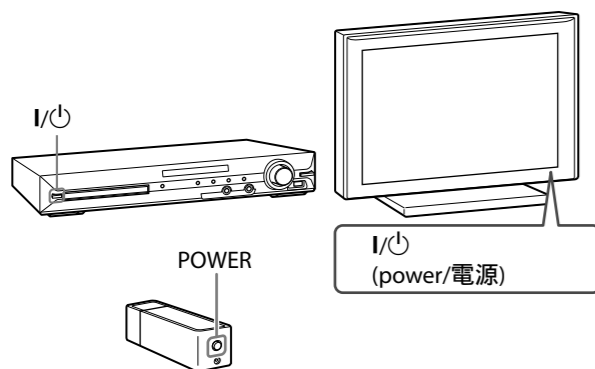

4 Performing the Quick Setup/執行快速設定

Note
Do not insert a disc before performing the Quick Setup.
注意
請勿於執行快速設定之前插入光碟。

- 1 Switch the input selector on your TV to display "SONY Home Theatre System."**
切換電視機上的輸入選擇器以顯示 "SONY Home Theatre System"。

- 2 Set each following item, using $\leftarrow/\rightarrow/\uparrow/\downarrow$ and \oplus .**
使用 $\leftarrow/\rightarrow/\uparrow/\downarrow$ 鍵和 \oplus 鍵，設定以下每個項目。

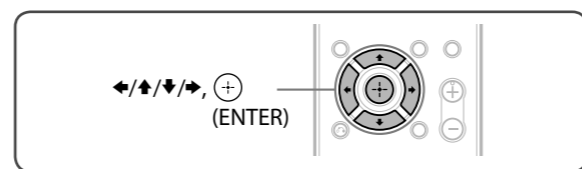

Note
Displayed items vary depending on the area.
注意
視地區而定，顯示項目會有不同。

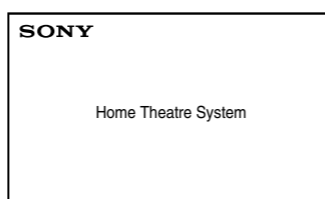

Select an on-screen language.
選擇畫面語言。

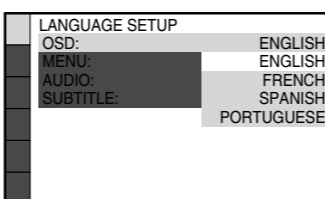

Select the aspect ratio of the connected TV.
選擇所連接電視機的縱橫比。

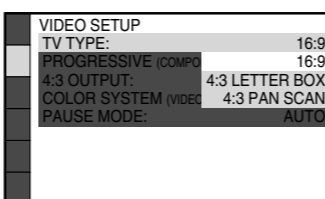

Select [ON] when you connect the main unit and the TV with an HDMI cable.

使用 HDMI 電纜連接主機與電視機時，請選擇 [ON]。

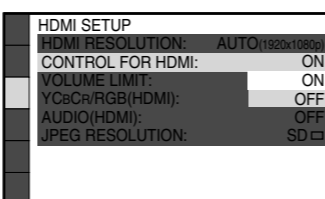

Select the speaker formation.
選擇揚聲器架構。

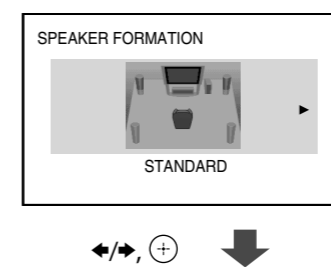

Connect the calibration mic and set it at the listening position.
連接校正麥克風並設定至聆聽位置。

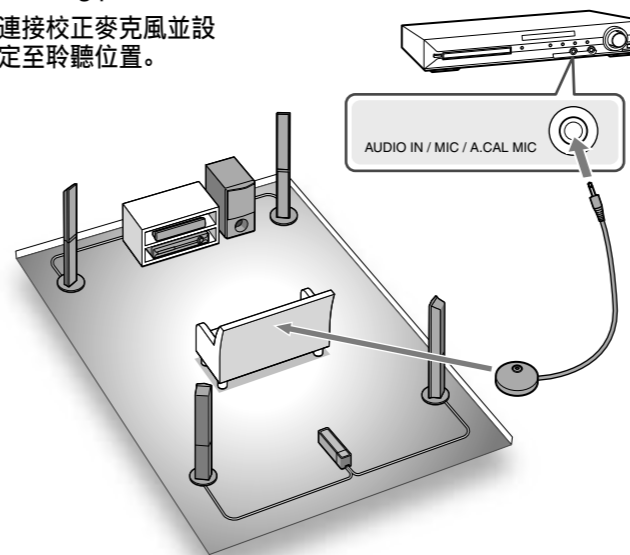

Select [YES] to perform [AUTO CALIBRATION].
選擇 [YES] 執行 [AUTO CALIBRATION]。

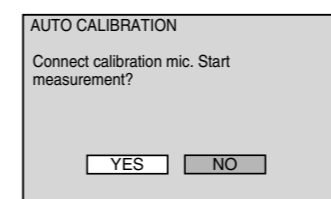

Select [YES] to save the measurement results.
選擇 [YES] 儲存測量結果。

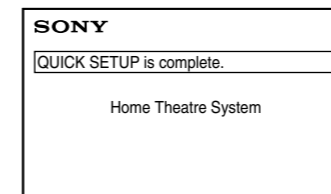
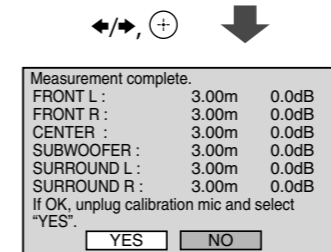

Listening to TV sound from all speakers/ 聆聽所有揚聲器的電視機聲音

- 1 Press FUNCTION to display "TV."**
按 FUNCTION 鍵顯示 "TV"。

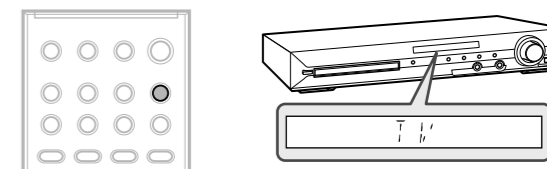

- 2 Press SYSTEM MENU.**
按 SYSTEM MENU 鍵。

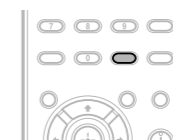

- 3 Press \uparrow/\downarrow to display "DEC. MODE," then press \oplus .**
按 \uparrow/\downarrow 鍵顯示 "DEC. MODE"，然後按 \oplus 鍵。

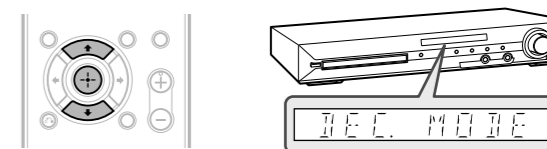

- 4 Press \uparrow/\downarrow to display "PRO LOGIC," then press \oplus .**
按 \uparrow/\downarrow 鍵顯示 "PRO LOGIC"，然後按 \oplus 鍵。

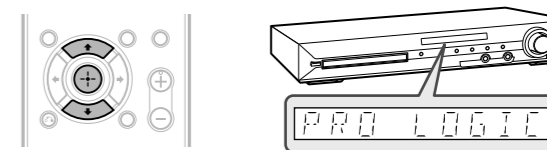

- 5 Press SYSTEM MENU to exit the menu.**
按 SYSTEM MENU 鍵退出菜單。

