

IC Recorder

Operating Instructions

IC RECORDER

ICD-S7

Notice for users

Program © 1999, 2000, 2001, 2002 Sony Corporation
Documentation ©2002 Sony Corporation

All rights reserved. This manual or the software described herein, in whole or in part, may not be reproduced, translated or reduced to any machine readable form without prior written approval from Sony Corporation.

IN NO EVENT SHALL SONY CORPORATION BE LIABLE FOR ANY INCIDENTAL, CONSEQUENTIAL OR SPECIAL DAMAGES, WHETHER BASED ON TORT, CONTRACT, OR OTHERWISE, ARISING OUT OF OR IN CONNECTION WITH THIS MANUAL, THE SOFTWARE OR OTHER INFORMATION CONTAINED HEREIN OR THE USE THEREOF.

Sony Corporation reserves the right to make any modification to this manual or the information contained herein at any time without notice.

The software described herein may also be governed by the terms of a separate user license agreement.

- This software is for Windows and cannot be used for Macintosh.
- The supplied connecting cable is for the IC recorder ICD-S7 only. You cannot connect other IC recorders.

Information

IN NO EVENT SHALL SELLER BE LIABLE FOR ANY DIRECT, INCIDENTAL OR CONSEQUENTIAL DAMAGES OF ANY NATURE, OR LOSSES OR EXPENSES RESULTING FROM ANY DEFECTIVE PRODUCT OR THE USE OF ANY PRODUCT.

Trademarks

- “LPEC” is the trademark of Sony Corporation.
- IBM and PC/AT are registered trademarks of International Business Machines Corporation.
- Microsoft, Windows and Outlook are trademarks of Microsoft Corporation, registered in the U.S.A. and other countries.

Copyright ©1995 Microsoft Corporation.

All rights reserved.

Portion Copyright ©1995 Microsoft Corporation

- Apple and Macintosh are trademarks of Apple Computer Inc., registered in the U.S.A. and other countries.
- Pentium is a registered trademark of Intel Corporation.
- NaturallySpeaking, Dragon Systems are trademarks owned by ScanSoft, Inc. and are registered in the United States and/or other countries.
- All other trademarks and registered trademarks are trademarks or registered trademarks of their respective holders. Furthermore, “™” and “®” are not mentioned in each case in this manual.

The “Digital Voice Editor” uses software modules as shown below:

Microsoft® DirectX® Media Runtime

©2001 Microsoft Corporation. All rights reserved.

Notes

- The illustrations in this manual may differ from the actual software.
- Explanations in this manual assume that you are familiar with basic operations of Windows. For how to use your computer and operating system, please refer to the respective manuals.

Table of Contents

Getting Started

| | |
|--|---|
| Step 1: Installing the Batteries | 6 |
| Replacing the Batteries | 7 |
| Step 2: Setting the Clock | 8 |

Basic Operations

| | |
|--|----|
| Recording Messages | 10 |
| Recording with an External Microphone or Other Equipment | 15 |
| Recording with an External Microphone | 15 |
| Recording from or with Other Equipment | 16 |
| Playing Back Messages | 17 |
| Using the Display Window | 22 |
| Selecting the Display Mode | 25 |
| Turning off the Display | 27 |

Various Ways of Playback

| | |
|--|----|
| Adjusting the Playback Speed — DPC (Digital Pitch Control) | 28 |
| Adding a Bookmark | 30 |
| Playing Back the Specified Section Repeatedly — A-B Repeat | 31 |

Editing Messages

| | |
|---|----|
| Adding a Recording | 32 |
| Adding a Recording to a Previously Recorded Message | 32 |
| Adding an Overwrite Recording during Playback | 33 |
| Erasing Messages | 34 |
| Erasing Messages one by one | 34 |
| Erasing All Messages in a Folder | 36 |
| Dividing a Message into Two/Combining Messages — Index Function ... | 37 |
| Dividing a Message by Adding an Index | 38 |
| Combining Messages by Erasing the Index | 39 |
| Moving Messages to a Different Folder | 41 |
| Adding Priority Mark(s)— Priority Mark Function | 42 |
| Adding Priority Mark(s) in the Stop Mode | 42 |
| Adding Priority Mark(s) during Playback | 43 |

Other Functions

| | |
|--|----|
| Playing Back a Message at a Desired Time with an Alarm | 44 |
| Turning off the OPR Indicator (LED) | 48 |
| Preventing Accidental Operation — HOLD Function | 49 |
| Formatting the Memory | 50 |
| Changing the Settings — MENU | 52 |
| Using the "Digital Voice Editor" Software | 55 |

Additional Information

| | |
|---|----|
| Precautions | 57 |
| Troubleshooting | 58 |
| Error Messages of the IC Recorder | 61 |
| System Limitations | 63 |
| Specifications | 64 |
| Index to Parts and Controls | 65 |
| Index | 67 |

► Getting Started

Step 1: Installing the Batteries

- 1 Slide and lift the battery compartment lid.

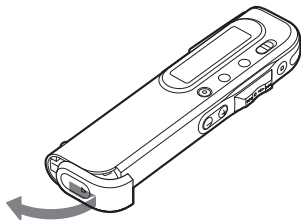

- 2 Insert two LR03 (size AAA) alkaline batteries with correct polarity, and close the lid.

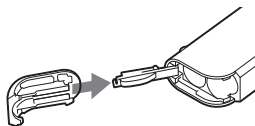
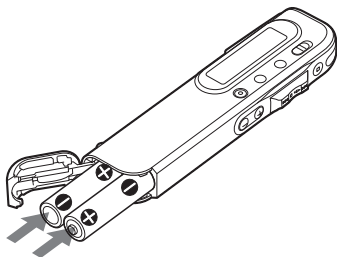

If the battery compartment lid is accidentally detached, attach it as illustrated.

Clock setting display appears when you insert batteries for the first time, or when you insert batteries after the unit has been without batteries for a certain period of time. Please refer to steps 3 to 6 in “Step 2: Setting the Clock” on pages 8 and 9 to set the date and time.

Using on house current

Connect the AC power adaptor AC-E30HG (not supplied) to the DC IN 3V jack of the unit and to the wall outlet. Do not use any other AC power adaptor.



Polarity of the plug

Replacing the Batteries

The battery indicator on the display window shows the battery condition.

Notes

- Do not use manganese batteries for this unit.
- When you replace the batteries, insert the new ones within 3 minutes after you remove the exhausted ones. Otherwise, the display may show the clock setting display or incorrect date and time when you re-insert the batteries. In this case, set the date and time again. The recorded messages and alarm setting, however, will remain.
- Do not charge dry batteries.
- When you are not going to use the unit for a long time, remove the batteries to prevent damage from battery leakage and corrosion.

Battery remain indication



: Replace both of the two batteries with new ones.



: The "LOW BATT" (low batteries) is displayed and the unit will stop operation.



Battery life (Using Sony alkaline batteries LR03 (SG))

| (Recording mode:) | SP | LP |
|--------------------------|-------------------|-------------------|
| In continuous recording: | Approx. 10 hours | Approx. 12 hours |
| In continuous playback: | Approx. 12 hours* | Approx. 13 hours* |

* When playing back through the internal speaker with the medium volume level

* The battery life may shorten depending on the operation of the unit.

Note on the "ACCESS" message

The unit is accessing data while "ACCESS" appears in the display window or the OPR indicator flashes in orange. While accessing, do not remove the batteries or AC adaptor. Doing so may damage the data.

Note

If the unit is required to process excessive amount of data, "ACCESS" may be displayed for an extended period of time. This is not a malfunction of the unit. Wait until the message disappears before starting operation.

Step 2: Setting the Clock

You need to set the clock to use the alarm function or record the date and time.

Clock setting display appears when you insert batteries for the first time, or when you insert batteries after the unit has been without batteries for a certain period of time. In this case, proceed from step 4.

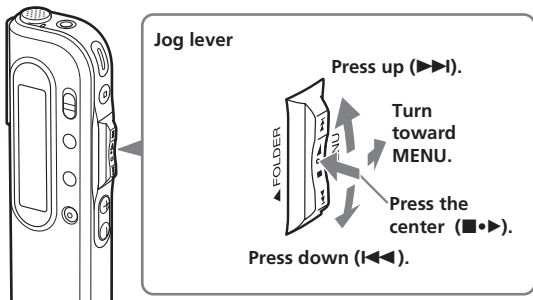

1 Turn the jog lever toward MENU.

The menu mode will be displayed in the display window.

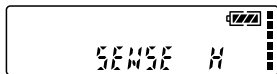

2 Press the jog lever up or down (▶▶/◀◀) to select "SET DATE".



3 Press the jog lever (■▶).

The date and time setting window is displayed. The year digits will flash.

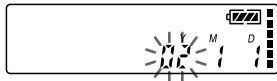

4 Set the date.

- ① Press the jog lever up or down (▶▶/◀◀) to select the digits of the year.

- ② Press the jog lever (■•►).
The month digits will flash.



- ③ Set the month and day in sequence, then press the jog lever (■•►).
The hour digits will flash.



5 Set the time.

- ① Press the jog lever up or down (►►/◄◄) to select the digits of the hour.
- ② Press the jog lever (■•►).
The minute digits will flash.
- ③ Set the minute.
- ④ Press the jog lever (■•►).
The menu mode will be displayed again.



Note

If you do not press the jog lever (■•►) for more than one minute, the clock setting mode is cancelled and the window will return to normal display.

6 Turn the jog lever toward MENU.

The window will return to normal display.



- ☞ If the unit is left unused for more than 3 seconds in the stop mode after the clock is set, the display will show the current time (page 25).

►Basic Operations

Recording Messages

You can record the maximum of 99 messages in each of the three (A, B, C) folders. You can record messages in the following three ways:

- Add a recording behind the last recorded message
- Add a recording to a previously recorded message (page 32)
- Add an overwrite recording (page 33)

This section explains how to add a recording behind the last recorded message.

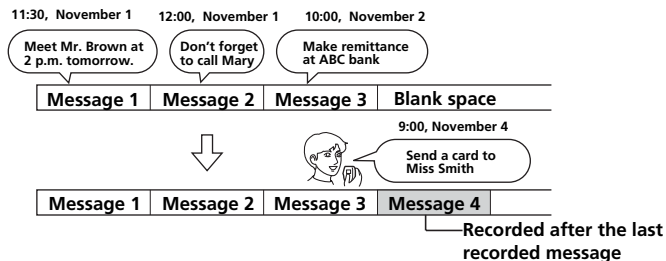

Maximum recording time

The maximum recording time of all the folders is as follows. You can record messages for the maximum recording time in a single folder.

| Recording mode: | SP* | LP** | SP and LP in a mixture |
|-------------------------|----------|------------|---|
| Maximum recording time: | 532 min. | 1,418 min. | 532 min. to 1,418 min. (min.: minutes) |

* SP: Standard play recording mode

**LP: Long play recording mode

Notes

- To record in better sound quality, select the SP mode. For switching the recording mode, see page 54.
- Before making a long recording, be sure to check the battery indicator (page 7).
- The maximum recording time and the number of messages you can make varies depending on the conditions of use.
- To avoid replacing batteries during long time recording, use the AC power adaptor (not supplied).

1

Select the folder.

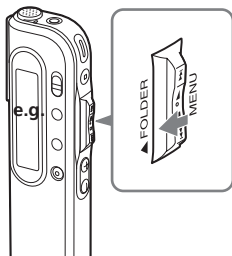

Turn the jog lever toward FOLDER repeatedly to display the folder (A, B, or C) in which you wish to record messages.

Selected folder

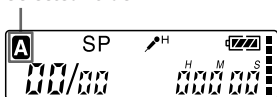

2

Start recording.

Built-in microphone

- ① Press ●REC/REC PAUSE button.
You do not need to keep pressing ●REC/REC PAUSE while recording.

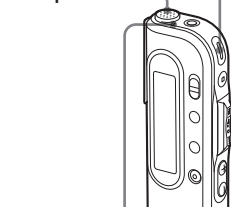

OPR indicator
(lights in red during recording**)

Recording mode indication

Microphone sensitivity indication

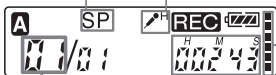

Remaining memory indication

Current message number

Counter display*

- ② Speak into the built-in microphone.

* The display selected with the DISPLAY in the menu (page 25) appears.

**When the LED in the menu is set to OFF, the OPR indicator turns off (page 48).

Continued

Recording Messages (continued)

Notes

- While the OPR indicator flashes or turns in orange, do not remove the batteries or the AC adaptor. Doing so may damage the data.
- When you connect an external speaker or a connecting cord to the EAR/MIC jack, you cannot record from the built-in microphone. Disconnect the speaker or cable.
- Noise may be recorded if an object, such as your finger, etc., accidentally rubs or scratches the unit during recording.

3 Stop recording.



Press ■STOP.

The unit stops at the beginning of the current recording. If you do not change the folder after you stop recording, the next time you record you will record in the same folder.

Other operations

| To | Do this |
|------------------------------------|--|
| pause recording* | Press ●REC/REC PAUSE. During recording pause, the OPR indicator flashes in red and "PAUSE" flashes in the display window. |
| release pause and resume recording | Press ●REC/REC PAUSE again. Recording resumes from that point. (To stop recording after pausing recording, press ■STOP.) |

| To | Do this |
|--|--|
| review the current recording instantly | Press the jog lever (■•▶). Recording stops and playback starts from the beginning of the message just recorded. |
| review during recording | Press the jog lever down (◀◀) during recording or recording pause. Recording stops and you can search backwards while listening to fast playback sound. After you release the jog lever, playback starts from that point. You can add an overwrite recording from that point. |

* 1 hour after you pause recording, recording pause is automatically released and the unit goes into the stop mode.

To select the sensitivity of the built-in microphone

You can select the microphone sensitivity by setting the SENSE in the menu according to the recording conditions:

H (high): To record at a meeting or in a quiet and/or spacious place.

L (low): To record for dictation or in a noisy place.

You can change the SENSE setting with the menu during recording (page 53).

To monitor the recording

When recording from the built-in microphone, you connect an earphone or headphones supplied or not supplied to the EAR/MIC jack and monitor the recording from the connected earphone or headphones. You can adjust the volume with VOL +/-, but the recording level is fixed.

Notes

- If you turn up the volume excessively or place the earphone near the microphone while monitoring recording, the microphone may pick up the sound from the earphone, causing acoustic feedback (howling sound).
- If you connect an external microphone or a connecting cable to the EAR/MIC jack and record from the connected device, you cannot connect an earphone or headphones to the jack; you cannot monitor the recording.

Recording Messages (continued)

Starting recording automatically in response to the sound — Advanced VOR function

You can set the VOR (voice operated recording) function in the menu. With VOR set to ON, recording starts when the recorder detects sound, and “VOR” appears in the display window. The recording pauses when no sound is detected, and “VOR PAUSE” appears. You can change the VOR setting with the menu during recording (page 53).

Note

VOR function is affected by the sound around you. Set the MIC SENSE to either H or L according to the recording conditions. If recording is not satisfactory after you have changed the microphone sensitivity, or for important recording, set the VOR to OFF.

Memory remain indication

During recording, the remaining memory indicator decreases one by one. When the remaining recording time reaches 5 minutes, the remaining memory indication flashes.



When the remaining time reaches 1 minute, the remaining time indication will flash in the display window regardless of the display mode (page 25).

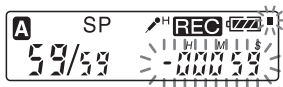

When the memory is full, recording automatically stops and “FULL” will be displayed with an alarm sound. To continue recording, first erase some of the messages (page 34).

Recording with an External Microphone or Other Equipment

You can record sound of an external microphone or other equipment (tape recorder, telephone, or etc.) with the IC recorder. You can also record the sound of the IC recorder with other equipment. Depending on the device you use, connect the IC recorder as follows. For available accessories, consult with your nearest Sony dealer.

Recording with an External Microphone

Connect an external microphone to the EAR/MIC jack.

When you connect an external microphone, the built-in microphone is automatically cut off. When a plug in power type microphone is connected, power is automatically supplied to the microphone from the IC recorder.

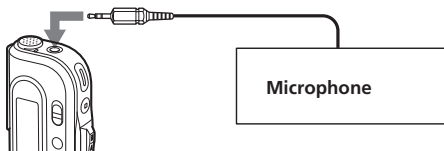

Recommended types of microphones

You can use the following Sony electret condenser microphones:

- Zoom microphone ECM-Z60
- ECM-T15, or ECM-T115
- ECM-DM5P

Using the built-in microphone and an external microphone

- The built-in microphone, an all-directional and standard sensitivity microphone, is suitable for recording a dictation or a meeting. (When recording a dictation, set the SENSE to L. When recording a meeting, set the SENSE to H.) (Page 53)
- An external microphone such as ECM-DM5P, a unidirectional and high sensitivity microphone, is suitable for recording a lecture or an interview. (When the speaker is located far from you, set the SENSE to H to record sound in better quality.)

Continued

Recording with an External Microphone or Other Equipment (continued)

Recording from or with Other Equipment

To record sound of other equipment with the IC recorder, connect the EAR/MIC jack of the IC recorder to the earphone jack of other equipment (tape recorder, television, radio or etc.) by using the registered connecting cable RK-G64 (not supplied).

To record the sound of the IC recorder with other equipment, connect the EAR/MIC jack of the IC recorder to the microphone jack of other equipment.

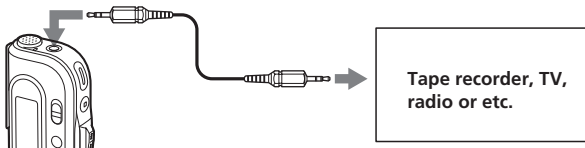

Note

If you use a connecting cable without register, sound may be recorded interrupted. Make sure to use a registered connecting cable.

Recording sound of a telephone

You may be able to use a commercially-available telephone recording adaptor to record telephone sound with the IC recorder. For available accessories, consult with your nearest Sony dealer.

Notes

- You cannot record sound of a cellular telephone because the noise occurs when placing the unit near a cellular telephone.
- You cannot record sound of some types of telephones or business phones.

Playing Back Messages

When playing back a previously recorded message, start from step 1. When playing back a message you have just finished recording, start from step 3.

1 Select the folder.

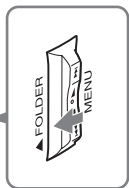
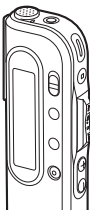

Turn the jog lever toward FOLDER repeatedly to display the folder (A, B, or C) in which you wish to play messages.

Selected folder

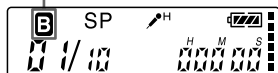

2 Select the message number.

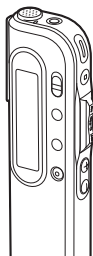

Press the jog lever up or down (▶▶/◀◀) to display the desired message number.

Press up (▶▶): for next message number.

Press down (◀◀): for previous message number.

Selected message number

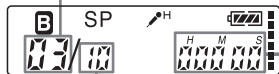

Counter display*

The number of message in a folder

* The display selected with the DISPLAY in the menu (page 25) appears.

Playing Back Messages (continued)

3 Start playback.

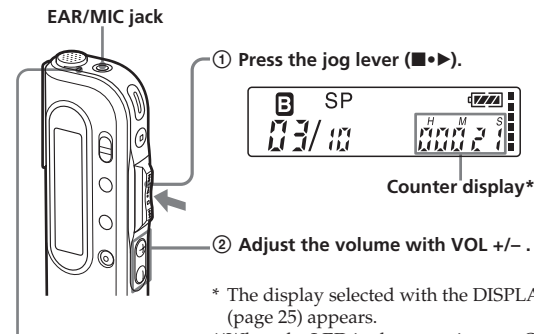

OPR indicator
(lights in green during playback**)

- * The display selected with the DISPLAY in the menu (page 25) appears.
**When the LED in the menu is set to OFF, the OPR indicator turns off (page 48).

After playing back one message, the unit stops at the beginning of the next message.

When the last message in a folder has been played back, the unit stops at the beginning of the last message.

To listen from an earphone or headphones

Connect an earphone or headphones (not supplied) to the EAR/MIC jack. The built-in speaker will be automatically disconnected. If you plug in headphones, you will get monaural output from both left and right channels.

To listen from an external speaker

Connect an active or passive speaker (not supplied) to the EAR/MIC jack. If you plug in two-channel type speakers, you will get monaural output from both left and right channels.

Notes

- While an external speaker or a connecting cable is connected to the EAR/MIC jack, you can hear beeps or playback sounds from the built-in speaker.
- When connecting an earphone or headphones (not supplied) during playback, make sure to plug it securely. If you plug it loosely, you may hear sounds from the built-in speaker. If this occurs, disconnect and then connect an earphone or headphones again.
- With some types of headphones, sound may come from both the built-in speaker and headphones. If this occurs, use the supplied earphone or the headphones recommended for the IC recorder.

Other operations

| To | Do this |
|--|--|
| stop at the beginning of the current message | Press ■STOP. |
| stop at the current position (Playback Pause function) | Press the jog lever (■●▶). To resume playback from that point, press the jog lever (■●▶) again. |
| go back to the beginning of the current message* | Press the jog lever down (◀◀) once.** |
| go back to previous messages | Press the jog lever down (◀◀) repeatedly. (During stop mode, keep the jog lever pressed to go back the messages continuously.) |
| skip to the next message* | Press the jog lever up (▶▶) once.** |
| skip to the succeeding messages | Press the jog lever up (▶▶) repeatedly. (During stop mode, keep the jog lever pressed to skip the messages continuously.) |

* If you have set a bookmark on the message, the unit stops at the bookmark.

** These operations are for when EASY-S is set to OFF. For operations when EASY-S is set to ON, see page 54.

Playing back a message rapidly or slowly — DPC (Digital Pitch Control)

When you adjust the playback speed with the DPC in the menu (page 28), you can play back a message rapidly or slowing by sliding the DPC switch to ON. When you set the playback speed faster or slower of the normal speed, "FAST" or "SLOW" appears. You can change the setting during playback.

Continued

Playing Back Messages (continued)

Playing back all messages in a folder continuously

— Continuous Play

When the CONT (page 53) is set to ON in the menu, you can play back all the messages in a folder continuously. You can change the setting during playback.

Locating quickly the point you wish to start playback (Easy Search)

When EASY-S is set to ON (page 54) in the menu, you can quickly locate the point you wish to start playback by pressing the jog lever up or down (▶▶|/|◀◀) repeatedly during playback or playback pause.

You can go back approx. 3 seconds by pressing the jog lever down (◀◀) once, or advance approx. 10 seconds by pressing the jog lever up (▶▶) once. This function is useful when locating a desired point in a long recording.

Searching forward/backward during playback (Cue/Review)

- **To search forward (Cue):** Keep pressing the jog lever up (▶▶|) during playback and release it at the point you wish to resume playback.
- **To search backward (Review):** Keep pressing the jog lever down (◀◀) during playback and release it at the point you wish to resume playback.

The unit searches at slow speed with playback sound. It is useful to check one word forward or behind. Then, if you keep pressing the jog lever up or down, the unit starts to search at higher speed. During cue/review, the counter will be displayed, regardless of the display mode setting (page 25).

🔔 *When playback is done to the end of the last message*

- When playback or fast playback is done to the end of the last message, “END” flashes for 5 seconds and the OPR indicator lights up in green. (You cannot hear the playback sound.)
- When “END” stops flashing and the OPR indicator goes off, the unit will stop at the beginning of the last message.
- If you keep pressing the jog lever down (◀◀) while “END” is flashing, the messages are played back rapidly, and normal playback will start at the point you release the button.

- If the last message is long and you wish to start playback at a later part of the message, keep pressing the jog lever up (▶▶) to go to the end of the message and then press the jog lever down (◀◀) while “END” is flashing to go back to the desired point.
- For messages other than the last one, go to the beginning of the next message and play backward to the desired point.

Playing back a message repeatedly — Repeat Play

During playback, press the jog lever (■•▶) for more than one second. “↻” will be displayed and the selected message will be played back repeatedly.

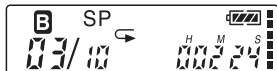

To resume normal playback, press the jog lever (■•▶) again. To stop playback, press ■STOP.

🔁 To play back the specified section repeatedly — A-B Repeat

You can specify the start (A) and end (B) points and play back the specified section repeatedly (page 31).

Using the Display Window

Parts in the display window

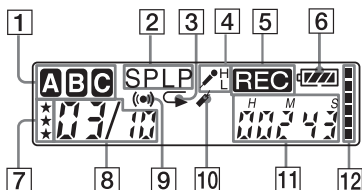

- 1** Folder indication
Displays the current folder (A, B, or C).
- 2** Recording mode indication (54)
Displays the current recording mode:
SP: Standard Play mode
LP: Long Play mode
- 3** Repeat play indicator (21, 31)
Appears while a message or a specific portion (A-B) of the message is played back repeatedly.
- 4** SENSE (microphone sensitivity) indication (53)
Displays the current microphone sensitivity:
H (high): To record at a meeting or in a quiet/spacious place.
L (low): To record for dictation or in a noisy place.
- 5** REC (Recording) indicator (11)
- 6** Remaining battery indicator (7)
When the AC power adaptor (not supplied) is connected, the indicator does not appear.
- 7** Priority marks (42)
- 8** Selected message number / Total message number in the folder (11, 17)
- 9** Alarm indicator (46)
Appears when the alarm is set for a message.
- 10** Bookmark indicator (30)
Appears when the bookmark is set for a message.
- 11** Counter / Remaining time indication / Recording date and time indication / Current time indication (25)
The display selected with the DISPLAY in the menu appears.
- 12** Remaining memory indicator (14)

■ Display during recording and playback

In an ordinary recording or playback mode, the message number, recording mode and microphone sensitivity of the message being recorded or played back, and playback counter are displayed in the window.

In a special recording or playback mode such as overwrite recording, A-B repeat playback, or DPC play, the mode flashes in the display.

■ Display during setting the menu

In menu setting mode, the menu items and current setting are displayed. You can change the setting while it is flashing.

In alarm or clock setting, the date and time setting display appears.

■ Display during adding or deleting

When you are trying to add or delete a message, a bookmark, or an index, the display flashes for confirmation. While the display is flashing, you can cancel adding or deleting.

Display examples

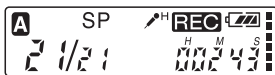

A message is being recorded as the 21st message of all 21 messages in the folder A in SP mode with H (high) microphone sensitivity.



When the DPC switch is set to ON to start playback rapidly

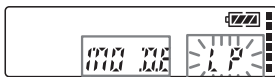

MODE menu LP recording mode is being selected.



"May 10, 2002" is being selected.

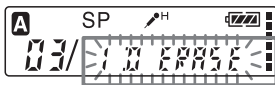

When you are trying to delete an index

Using the Display Window (continued)

■ Remain indications

When the battery or memory runs out, the remain indications flash in the display.

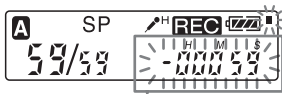

When the remain time becomes shorter than 1 minute

■ Error messages

The error messages or error numbers will be displayed (page 61).



When an access error occurs



When an error number is displayed

Selecting the Display Mode

You can select the display mode for stop, recording and playback modes.

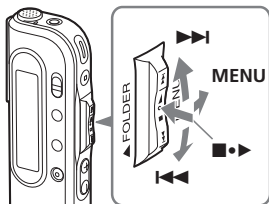

- 1 Turn the jog lever toward MENU.**
The menu mode will be displayed.

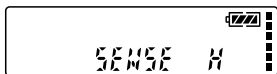

- 2 Press the jog lever up or down (▶▶/◀◀) to select "DISPLAY".**

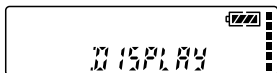

- 3 Press the jog lever (◼•▶).**
The display setting window will be displayed.

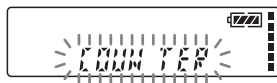

- 4 Press the jog lever up or down (▶▶/◀◀) to select the display mode.**

The display modes changes in the order shown to the right.



- 5 Press the jog lever (◼•▶).**

- 6 Turn the jog lever toward MENU.**

The menu mode exits and the normal mode is displayed.

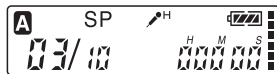

On current time display

If the unit is left unused for more than 3 seconds in the stop mode, the display will turn to the current time display mode as shown to the right, regardless of the display mode setting.

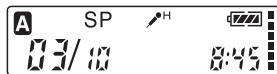

Continued

Selecting the Display Mode (continued)

You can select the display mode from the following:

■ COUNTER (elapsed time)

Elapsed playback/recording time of one message.



■ REMAIN (remaining time)

In the playback mode: The remaining time of one message indication.

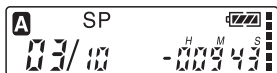

In the stop and recording mode: The remaining recording time indication.

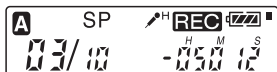

■ REC DATE (recorded date)

In the playback and playback pause modes, the date the current message was recorded.

In the recording mode, the current date.

(If the clock has not been set, "--Y--M--D" will be displayed.)



■ REC TIME (recorded time)

In the playback and playback pause modes, the time the current message was recorded.

In the recording mode, the current time.

(If the clock has not been set, "--:--" will be displayed.)

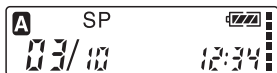

Turning off the Display

The unit is not equipped with the power button. The display always appears on the window, which almost will not influence the battery life. To turn off the display, slide the HOLD switch in the direction of the arrow in the stop mode.

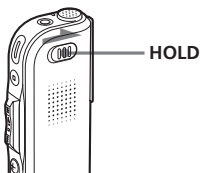

“HOLD” will flash for three seconds and then the display turns off in the window. To turn on the display, slide the HOLD switch in the opposite direction.

► Various Ways of Playback

Adjusting the Playback Speed — DPC (Digital Pitch Control)

You can adjust the speed of the playback between twice the normal speed (+100%) and half the normal speed (-50%). The message is played back in natural tone thanks to the digital processing function.

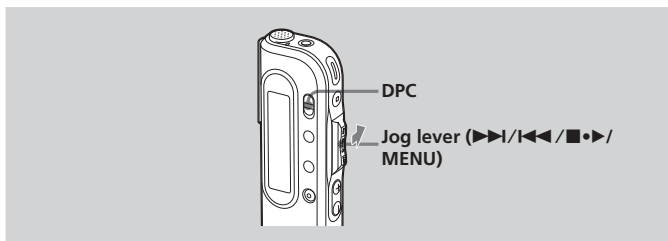

Playing back a message rapidly or slowly

Slide the DPC switch to ON.
"FAST" or "SLOW" flashes for 3 seconds
and the message is played back at the
speed specified with the menu.

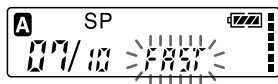

To resume normal playback

Slide the DPC switch to OFF.

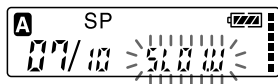

Setting the playback speed

You can set the playback speed when the DPC switch is set to ON. The setting for the playback speed holds effective until you change the setting.

- 1 Turn the jog lever toward MENU to display the menu mode.



- 2 Press the jog lever up or down (▶▶/◀◀) to select "DPC", then press the jog lever (■•▶).

The playback speed setting mode will be displayed. The flashing number represents the playback speed in percentage with the standard speed as "0".



- 3 Press the jog lever up or down (▶▶/◀◀) to set the playback speed.

- Fast play (up to +100% by 10%): Press up (▶▶).
- Slow play (down to -50% by 5%): Press down (◀◀).

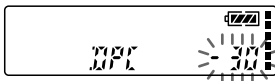

- 4 Press the job lever (■•▶). The specified playback speed is confirmed.



- 5 Press the jog lever toward MENU to exit the menu mode. The normal display appears.

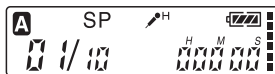

Adding a Bookmark

You can add a bookmark at a point in a message and use it during playback. You can add only one bookmark in each message.

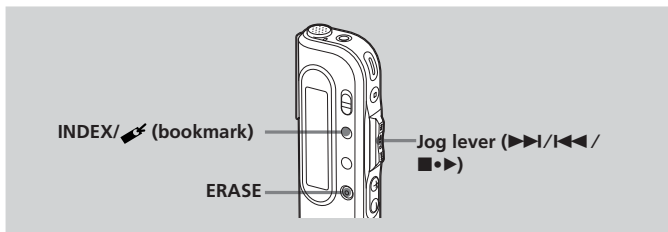

During playback or stop, press INDEX/ [pencil icon] (bookmark) for more than 1 second.

A bookmark is added and the bookmark indicator ([pencil icon] and "BOOKMARK") flashes for 3 seconds.



If you add a bookmark to a message that already has a bookmark, a previously added bookmark is deleted and a bookmark is added to the newly specified point.

To start playback at the bookmark

Press the jog lever up or down (▶▶|/|◀◀) during stop so that the bookmark indicator flashes for 3 seconds. Then press the jog lever (■•▶).

To delete the bookmark

- 1 In stop mode, press the jog lever up or down (▶▶|/|◀◀) to display the number of the message with the bookmark you wish to delete.
- 2 While pressing INDEX/ [pencil icon] (bookmark), press ERASE for more than 1 second.
- 3 Press ERASE while the bookmark indicator and "ERASE " are flashing.

Note

You cannot add an index to an MSV (ADPCM) file message recorded with the IC recorder ICD-MS1.

Playing Back the Specified Section Repeatedly — A-B Repeat

While playing back a message, you can set the start (A) and end (B) points for a section you wish to play repeatedly.

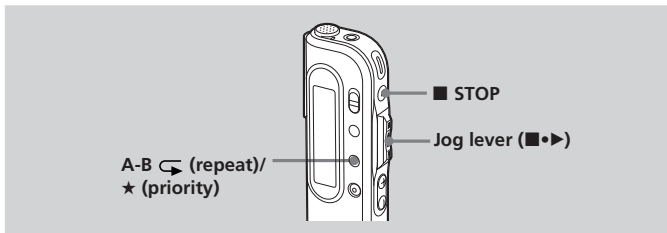

- 1** During playback, press A-B ↶ (repeat)/★ (priority) briefly.
The starting point (A) of the section you wish to play repeatedly is set.
"A-B B" flashes.



- 2** During playback, press A-B ↶ (repeat)/★ (priority) briefly.
The finishing point (B) of the section is set.
"A-B" and "↶" are displayed and the specified section is played back repeatedly.

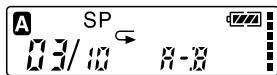

To resume normal playback

Press the jog lever (■▶).

To stop A-B Repeat playback

Press ■STOP.

Notes

- You cannot set A-B Repeat for a section that overlaps two or more messages.
- If you do not set the finishing point (B), the finishing point is automatically set at the end (or the beginning) of the message.

Adding a Recording

Notes

- The added or overwritten portion of a message will be recorded in the same recording mode (SP or LP; see page 54) as the original message, regardless of the current recording mode setting.
- You cannot add or overwrite a recording if the remaining memory is not long enough. For more information, see “Troubleshooting” (page 58).
- You cannot add or overwrite a recording to an MSV (ADPCM) file message recorded with the IC recorder ICD-MS1.

Adding a Recording to a Previously Recorded Message

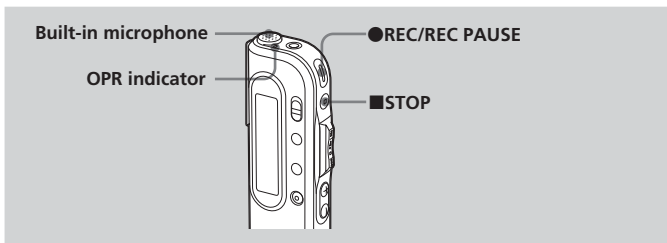

You can add a recording to the message being played back. The added recording will be placed after the current message and counted as a part of the message.

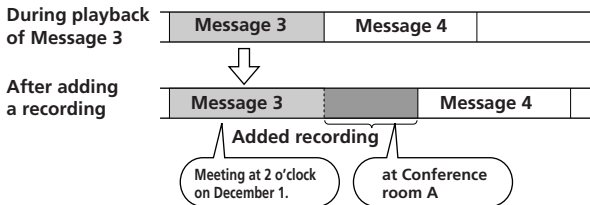

- 1 During playback, press ● REC/ REC PAUSE for more than 1 second.

The “REC” is displayed and “ADD” flashes for 3 seconds on the display window. The OPR indicator will turn red. Then the new recording will be added at the end of the current message.

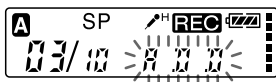

- 2 Press ■ STOP to stop the recording.

Adding an Overwrite Recording during Playback

You can add an overwrite recording after the selected point in a recorded message. The part of the message after the selected point is deleted.

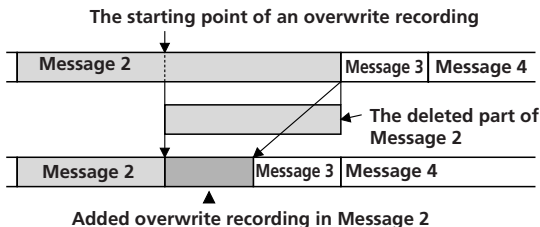

- 1 During playback, press ● REC/ REC PAUSE briefly.

The “REC” is displayed. “OVER” flashes on the display window and the OPR indicator flashes in red.

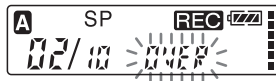

- 2 Press ● REC/ REC PAUSE to start recording.

The display returns to the display mode set in the menu and the OPR indicator turns red.

- 3 Press ■ STOP to stop the recording.

Erasing Messages

You can erase the recorded messages one by one or all messages in a folder at a time.

Note

Once a recording has been erased, you cannot retrieve it.

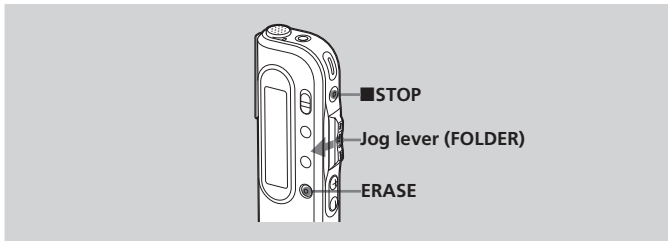

Erasing Messages one by one

You can erase unnecessary messages only.

When a message is erased, the remaining messages will advance and be renumbered so that there will be no space between messages.

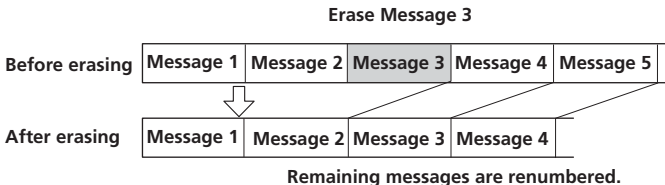

- 1 Press ERASE while playing back the message you want to erase or press ERASE for more than 1 second during stop mode.**

The message number and “ERASE” will flash while the first and last 5 seconds of the message are played back 10 times.

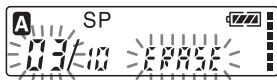

- 2 Press ERASE while the message is being played back and “ERASE” is flashing.**

The message is erased and the remaining messages will be renumbered. (For example, if you erase Message 3, Message 4 will be renumbered as Message 3. When erasing is completed, the unit will stop at the beginning of the following message.)

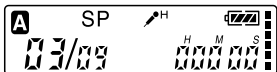

To cancel erasing

Press ■STOP before step 2.

To erase other messages

Repeat steps 1 and 2.

To erase a message partially

First divide the message by adding an index (see page 38) and then follow the steps on this page to erase the message.

Erasing Messages (continued)

Erasing All Messages in a Folder

You can erase all recorded messages in a folder.

- 1 Turn the jog lever toward **FOLDER** repeatedly to display the folder (A, B, or C) containing the messages you want to erase.

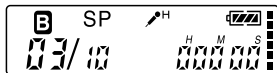

- 2 While pressing **STOP**, press **ERASE** for more than 1 second. The message number and "ALL ERASE" will flash for 10 seconds.

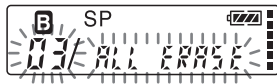

- 3 While "ALL ERASE" is flashing, pressing **ERASE**. All the recorded messages contained in the folder are deleted. The folder itself will not be deleted.

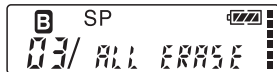

To cancel erasing

Press **STOP** before step 3.

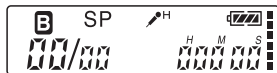

Dividing a Message into Two/ Combining Messages — Index Function

You can divide a message by adding an index, or combine messages by erasing the index.

- While recording/playing back messages, you can add an index (see page 38).
- In stop mode, you can erase the index (see page 39).

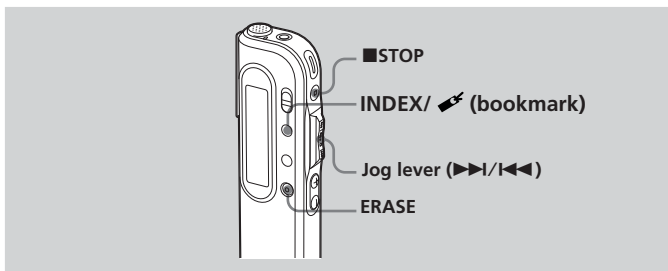

Notes

- Due to the recording system of an IC recorder, you may not be able to add or delete an index in some cases (pages 60 and 63).
- You cannot add or erase an index to an MSV (ADPCM) file message recorded with the IC recorder ICD-MS1.

Dividing a Message into Two/Combining Messages — Index Function (continued)

Dividing a Message by Adding an Index

You can add an index to a message during recording or playback, so that the message is divided into two and the new message number is added to the divided message. By dividing a message, you can easily find the point you want to play back when you make a long recording such as a meeting. You can add indexes until the total number of messages in the folder becomes 99.

Notes

- You need a certain amount of space in the memory to add an index. For more information, see “System Limitations” on page 63.
- If you add an index to a message with priority mark(s), priority mark(s) will be added to both parts of the divided message.
- If you add an index to the point the bookmark is specified, the bookmark is erased.

While recording or playing back a message, press INDEX/  (bookmark) at the point you want to divide.

- **When you press INDEX/  (bookmark) during recording:**

The new message number is added at the point you pressed the button, and the new message number and “ID ADD” flashes for 3 seconds. The message will be divided into two; however, the messages will be recorded without a break.

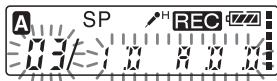

| | | |
|-----------|-----------|-----------|
| Message 1 | Message 2 | Message 3 |
|-----------|-----------|-----------|

An index  is added.

→ Recording continues.

Tip

You can add an index during recording pause.

- **When you press INDEX/  (bookmark) during playback:**

The message is divided into two at the point you pressed the button, and the new message number and “ID ADD” flashes for 3 seconds. The message numbers of the following messages will increase by one.

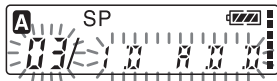

| | | | |
|-----------|---------------------------|-----------|-----------|
| Message 1 | Message 2 | Message 3 | |
| | ↓ ▲ An index is added. | | |
| Message 1 | Message 2 | Message 3 | Message 4 |

The message numbers increase.

To play the message you marked with an index

Press the jog lever up or down (/|/|) to display the message number as the divided messages have message numbers.

To play the divided messages continuously

Select ON for CONT in the menu as described in “Changing the Settings” on page 53.

Combining Messages by Erasing the Index

You can combine two messages into one by erasing the index.

| | | | |
|-----------|----------------------------|-----------|-----------|
| Message 1 | Message 2 | Message 3 | Message 4 |
| | ↓ ▲ An index is erased. | | |
| Message 1 | Message 2 | Message 3 | |

The message numbers decrease.

Notes

- After combining messages by erasing an index, the latter message’s alarm setting, priority mark(s) and bookmark will be deleted.
- If a bookmark has been added to the message, the above steps first delete the bookmark (page 30). Repeat the steps to erase the index.

Continued

Dividing a Message into Two/Combining Messages — Index Function (continued)

- 1 Press **■STOP** to stop the IC recorder.
- 2 Press the jog lever up or down (**▶▶|/|◀◀**) to display the number of the second of the two messages you want to combine.

- 3 While pressing **INDEX/**  (bookmark), press **ERASE** for more than 1 second.

“ID ERASE” will flash for 10 seconds.



- 4 Press **ERASE** while the display is flashing.

The two messages are combined into one and the messages will be renumbered as in the illustration on page 39.

To cancel erasing

Press **■STOP** before step 4.

Moving Messages to a Different Folder

You can move the recorded messages to another folder. When you move a message to another folder, the one in the previous folder will be deleted.

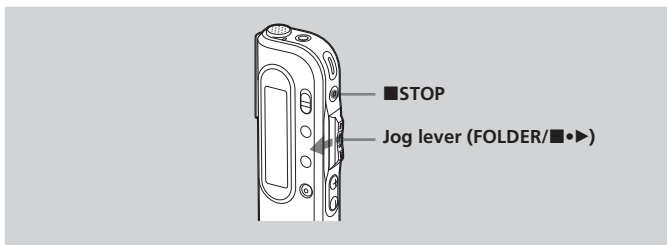

Example: Moving Message 3 in Folder A to Folder C

- 1 Play back the message you want to move.



- 2 Turn the jog lever toward FOLDER repeatedly to select the folder that you want to move the message into.

The destination folder and "MOVE" flash. The first and last 5 seconds of the message will be played back.

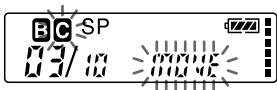

- 3 Press the jog lever (STOP/Next).

The message is moved to the destination folder. Messages are sorted in order of the recorded date and time or the number of the priority marks in the folder.

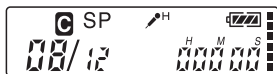

To cancel moving the message

Press STOP before step 3.

Adding Priority Mark(s)

— Priority Mark Function

Usually the recorded messages are lined up in the order of recording. By adding priority marks (★) to important messages, you can renumber the messages in the order of their priority. There are four levels, “★★★★” (the most important), “★★★”, “★★”, and no priority mark. You can add priority marks both in the stop mode and in the playback mode.

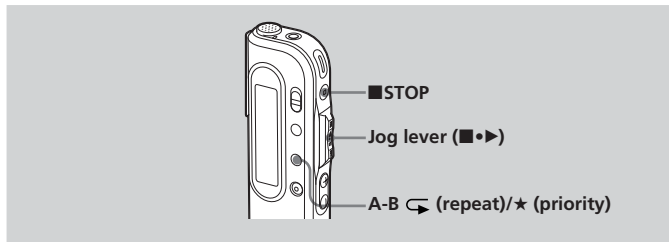

Adding Priority Mark(s) in the Stop Mode

- 1 Select the message you want to mark.

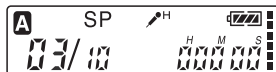

- 2 Press A-B (repeat)/★ (priority) for more than 1 second. "★" and "PRIORITY" will flash on the display window.

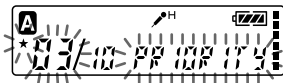

- 3 Press A-B (repeat)/★ (priority) repeatedly to select the number of priority mark(s) (★) while "PRIORITY" is flashing.

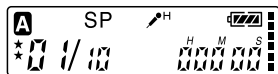

The setting is finished when the priority mark(s) (★) light(s) steadily in the display window and the messages are renumbered.

Adding Priority Mark(s) during Playback

- 1** Press A-B \curvearrowright (repeat)/★ (priority) button for more than 1 second during playback of the message you want to mark.

“★” and “PRIORITY” will flash on the display window while the first and last 5 seconds of the message is played back 10 times.

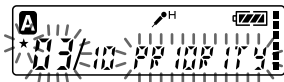

- 2** Press A-B \curvearrowright (repeat)/★ (priority) repeatedly to select the number of priority mark(s) (★).



- 3** Press the jog lever (■•►) to fix the setting.

The setting is finished and the messages will be renumbered.

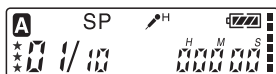

Messages with priority mark(s)

Messages are sorted in order of the number of priority mark(s) (★) in a folder. Messages without a priority mark are moved behind the messages with priority mark(s).

Tip

If there are over 2 messages with the same number of priority marks in a folder, these messages are sorted by the recorded date and time (The oldest one comes first).

Note

You can also add priority mark(s) using the supplied “Digital Voice Editor” software. But messages are not sorted in order of the number of the priority marks unless you sorted by the number of priority marks using the software.

e.g. When there are 3 messages in a folder

Message 1



Message 2



Message 3



►Other Functions

Playing Back a Message at a Desired Time with an Alarm

You can sound an alarm and start playback of a selected message at a desired time. You can have the message played back at a specified date, once every week, or the same time everyday.

You can also sound the alarm without playing back a message.

Note

When the clock is not set or no messages are recorded, you cannot set the alarm.

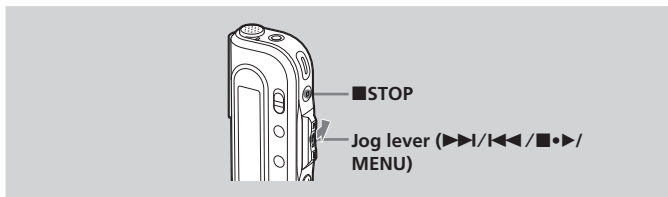

1 Select the message you want to play back.

For more information about selecting the desired message, see step 1 and 2 of “Playing Back Messages” on page 17.

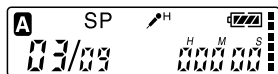

2 Enter the alarm setting mode.

- ① Press the jog lever toward MENU.
The menu mode will be displayed in the display window.

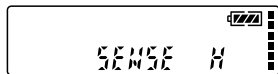

- ② Press the jog lever up or down (▶▶/◀◀) to select “ALARM OFF”.
If the alarm has been already set to “ON”, “ALARM ON” will be displayed.

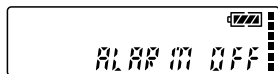

- ③ Press the jog lever (■•▶).
The alarm setting mode will be displayed in the display window.



- ④ Press the jog lever up or down (▶▶/◀◀) to select "ON".
If "ON" has already been selected, follow the next step.

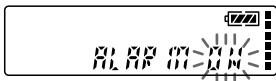

- ⑤ Press the jog lever (■•▶).
"DATE" will be displayed in the display window.

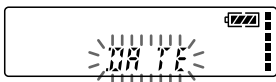

3 Set the alarm date and time.

To play back on a desired date

- ① Press the jog lever (■•▶) while "DATE" is displayed.
The year digits will flash.
- ② Press the jog lever up or down (▶▶/◀◀) to select the year digits and press the jog lever (■•▶).
The month digits will flash.
- ③ Set the month and the day in sequence, then press the jog lever (■•▶).

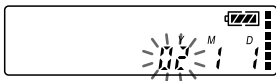

To play back once a week

Press the jog lever up or down (▶▶/◀◀) to select the day of the week ("SUN" for Sunday to "FRI" for Friday). Then press the jog lever (■•▶).

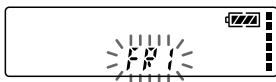

To play back at the same time every day

Press the jog lever up or down (▶▶/◀◀) to select "DAILY". Then press the jog lever (■•▶).

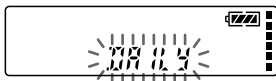

Playing Back a Message at a Desired Time with an Alarm (continued)

4 Select the alarm time.

- ① Press the jog lever up or down (▶▶|/|◀◀) to select the hour digits, and press the jog lever (■•▶).

The minute digit will flash.

- ② Press the jog lever up or down (▶▶|/|◀◀) to select the minute digits, and press the jog lever (■•▶).

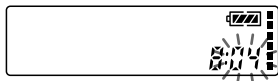
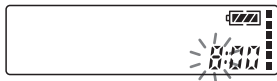

5 Press the jog lever up or down (▶▶|/|◀◀) to select the alarm sound either from "BEEP PLAY" (for starting playback after the alarm) or "BEEP ONLY" (for only the alarm).

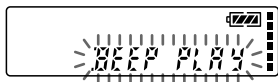

6 Press the jog lever (■•▶).

The setting is finished.

7 Press the jog lever toward MENU to exit the menu mode.

The normal display appears.

"(●)" is displayed when the message having an alarm setting is selected.



When the set date and time comes

At the set time, the alarm will sound for about 10 seconds and the selected message will be played back (If you have selected "BEEP ONLY" in step 5, only the alarm will sound).

During alarm playback, "ALARM" will flash in the display window.

When the playback ends, the unit will stop automatically at the beginning of that message.

To listen to the same message again

Press the jog lever (■•▶). The same message will be played back from the beginning.

To cancel the alarm setting before the playback starts

Press ■STOP while the alarm sound is heard. You can stop the alarm playback even when the HOLD function is activated.

To cancel the alarm setting

In step 2 on page 44, select “OFF” and then press the jog lever (■•▶).

To check the alarm setting

Follow steps 1 through 2 on page 44 to display the current alarm date and time. Then follow steps 3 to 7 on pages 45 and 46 to change the alarm date and time.

Notes

- If the alarm time comes while another message is being played back with an alarm, the playback stops and the new message will be played back.
- If the alarm time comes during recording, the alarm will sound after the recording is finished. “(●)” will flash when the alarm time comes.
- If more than one alarm time comes during recording, only the first message will be played back.
- When the alarm time comes when the unit is in the menu mode, alarm will sound and the menu mode will be cancelled.
- If you add an index to the message you set the alarm for, alarm setting remains on only the first part of the divided message.
- If you erase the index on the message you set the alarm for, the alarm setting of the latter message will be cancelled.
- Alarm setting will not be cancelled when the alarm playback finishes.

Turning off the OPR Indicator (LED)

During recording and playback, the OPR (operation) indicator lights or flashes. You can set the OPR indicator to turn off even in operation.

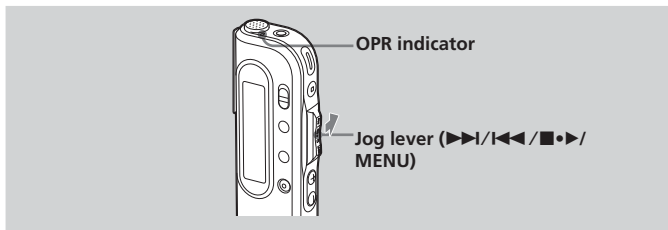

- 1** Turn the jog lever toward MENU.
The menu mode will be displayed.



- 2** Press the jog lever up or down (▶▶|/|◀◀) to select "LED ON".

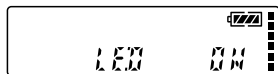

- 3** Press the jog lever (■▶).
The LED setting mode will be displayed.



- 4** Press the jog lever up or down (▶▶|/|◀◀) to select "OFF", and then press the jog lever (■▶).
The setting is changed.

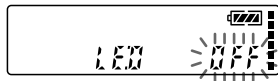

- 5** Press the jog lever toward MENU
to exit the menu mode.
The normal display appears.

To turn on the OPR indicator

In step 4, select "ON" and then press the jog lever (■▶).

Preventing Accidental Operation — HOLD Function

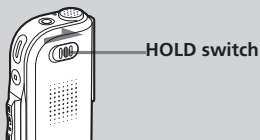

Slide the HOLD switch in the direction of the arrow. "HOLD" will flash for 3 seconds, indicating that all the functions of the buttons are locked. When the HOLD function is activated during stop, all the display will be turned off after "HOLD" flashes.



To cancel the HOLD function

Slide the HOLD switch in the opposite direction.

Tip

Even if the HOLD function is activated, you can stop the alarm playback. To stop the alarm or playback, press ■STOP. (You cannot stop usual playback.)

Formatting the Memory

You can format the memory in the IC recorder. Formatting will delete all the recorded messages and all other data recorded in the IC recorder. Before formatting, check the data in the IC recorder.



Jog lever (▶▶|/|◀◀/■•▶/
MENU)

- 1 Turn the jog lever toward MENU.**
The menu mode will be displayed in the display window.
- 2 Press the jog lever up or down (▶▶|/|◀◀) to select "FORMAT NO".**
- 3 Press the jog lever (■•▶).**
The formatting window will be displayed.
- 4 Press the jog lever up or down (▶▶|/|◀◀) to select "YES".**
- 5 Press the jog lever (■•▶).**
"OK" flashes for confirmation.

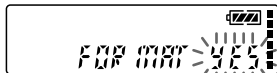
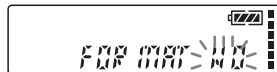
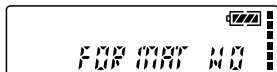

6 Press the jog lever (■•▶) again.

Formatting starts.

“FORMAT” flashes during formatting.

When the formatting is completed, “FORMAT NO” will be displayed again.

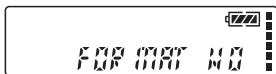

7 Press the jog lever toward MENU to exit the menu mode.

The window will return to normal display.

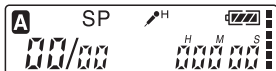

To cancel formatting

Select “NO” in the step 4 or press ■STOP while “FORMAT OK” is displayed in step 5.

Changing the Settings — MENU

You can use the menu to change the IC recorder settings. During playback and recording, the menu items to be displayed are limited. Follow the procedures below to display the menu and change the settings:

- ① Turn the jog lever toward MENU.
The menu mode will be displayed.
- ② Press the jog lever up or down (▶▶/◀◀) to select the menu item for which you want to change setting.
- ③ Press the jog lever (■•▶).
The setting mode of the selected menu item will be displayed.
- ④ Press the jog lever up or down (▶▶/◀◀) to select the setting that you want to set, and then press the jog lever (■•▶).
The setting will be changed.
- ⑤ Turn the jog lever toward MENU to exit the menu mode.
The window will return to normal display.

Note

If you do not press any keys for one minute, the menu mode is automatically cancelled and the window will return to normal display.

| Menu items | Settings (*: Initial setting) | Stop/Play/Rec** |
|------------|--|-----------------|
| SENSE | Displays the window to set the microphone sensitivity. | |
| | H *(high): To record at meetings or in a quiet and/or spacious place. | OK/-/OK |
| | L (low): To record dictation or in a noisy place. | |
| VOR | Displays the window to set the VOR (Voice Operated Recording) function. | |
| | ON: The VOR function is activated. Recording starts when the unit detects sound and stops when no sound is heard, eliminating recording from soundless period. | OK/-/OK |
| | OFF*: The VOR function is disabled. Normal recording operation is selected. | |
| DPC | Displays the window to set the playback speed (ON/OFF*). See page 28. | OK/OK/- |
| CONT | Displays the window to set the continuous play. | |
| | ON: You can play back all messages in a folder continuously. | OK/OK/- |
| | OFF*: Playback stops at the end of each message. | |

**Displays whether you can change the setting in each operation mode (Stop: stop mode/Play: playback mode/Rec: recording mode): "OK" shows the setting can be changed and "-" shows the setting cannot be changed.

Continued

Changing the Settings — MENU (continued)

| Menu items | Settings (*: Initial setting) | Stop/Play/Rec** |
|------------|--|-----------------|
| EASY-S | Displays the window to set the easy search function. ON: You can go back for approx. 3 seconds by pressing the jog lever down (◀◀), or advance for approx. 10 seconds by pressing the jog lever up (▶▶). OFF*: You can go back or forward the messages by pressing the jog lever down or up (◀◀/▶▶). | OK/-/- |
| BEEP | ON*: A beep will sound to indicate that operation has been accepted. OFF: No beep sound will be heard except for the alarm. | OK/-/- |
| ALARM | Displays the window to set the alarm (ON/OFF*). See page 44. | OK/-/- |
| FORMAT | Displays the window to format the IC recorder memory (YES/NO*). See page 50. | OK/-/- |
| SET DATE | Displays the window to set the clock (02Y1M1D*). See page 8. | OK/-/- |
| DISPLAY | Displays the window to change the display mode (COUNTER*). See page 25. | OK/OK/OK |
| MODE | Displays the window to set the recording mode: SP*: You can record with better sound. LP: You can record for longer time. | OK/-/- |
| LED | Displays the window to turn on or off the OPR indicator during operation (ON*). See page 48. | OK/-/- |

Using the "Digital Voice Editor" Software

By connecting the IC recorder to your computer with the supplied USB cable, you can use the "Digital Voice Editor" software to do the following:

- Saving the IC recorder messages on your computer's hard disk.
- Transferring the PC messages back to the IC recorder.
- Playing or editing the messages on your computer.
- Sending a voice e-mail message using MAPI e-mail software.
- Transcribing your IC recorder message using Dragon

NaturallySpeaking® speech-recognition software (not supplied).
For the details, see the supplied "Digital Voice Editor 2" software operating instructions.

Connection

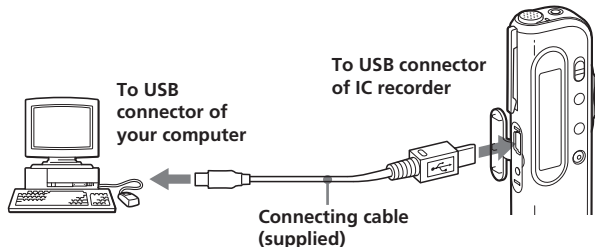

Continued

Using the "Digital Voice Editor" Software (continued)

System requirements

Your computer and system software must meet the following minimum requirements.

- IBM PC/AT or compatible
 - CPU: 266MHz Pentium® II processor or higher
 - RAM: 64MB or more
 - Hard disk space: 70MB or more depending on the size and number of sound files you store
 - CD-ROM drive
 - USB port
 - Sound board: Sound Blaster 16 compatible
 - Display: High color (16 bits) or more and 800 x 480 dots or more
- OS: Microsoft® Windows® XP Home Edition/XP Professional/2000 Professional/Millennium Edition/98/98 Second Edition standard installation (You cannot use this software with Windows® 95 or Windows® NT.)

Notes

- You cannot use the software with a Macintosh machine.
- A handmade computer, a computer whose operating system is installed or upgraded by the user, or a computer with multi-boot operating environment are not supported.

Precautions

On power

- Operate the unit only on 3 V DC. Use two LR 03 (size AAA) alkaline batteries.

On safety

- Do not operate the unit while driving, cycling or operating any motorized vehicle.

On handling

- Do not leave the unit in a location near heat sources, or in a place subject to direct sunlight, excessive dust or mechanical shock.
- Should any solid object or liquid fall into the unit, remove the batteries and have the unit checked by qualified personnel before operating it any further.

On noise

- Noise may be heard when the unit is placed near an AC power source, a fluorescent lamp or a mobile phone during recording or playback.
- Noise may be recorded when an object, such as your finger, etc., rubs or scratches the unit during recording.

On maintenance

- To clean the exterior, use a soft cloth slightly moistened in water. Do not use alcohol, benzene or thinner.

Keep personal credit cards using magnetic coding or spring-wound watches, etc., away from the unit to prevent possible damage from the magnet used in the speaker.

If you have any questions or problems concerning your unit, please consult your nearest Sony dealer.

Backup recommendations

To avoid potential risk of data loss caused by accidental operation or malfunction of the IC recorder, we recommend that you save a backup copy of your recorded messages on a tape recorder or to a computer, etc.

Troubleshooting

Before taking the unit for repair, check the following sections. Should any problem persist after you have made these checks, consult your nearest Sony dealer.

IC Recorder

| Symptom | Remedy |
|---|--|
| The unit does not operate. | <ul style="list-style-type: none">•The batteries have been inserted with incorrect polarity (page 6).•The batteries are weak.•The buttons are locked with the HOLD switch (page 49). (If you press any button, "HOLD" will flash for 3 seconds.) |
| No sound comes from the speaker. | <ul style="list-style-type: none">•The earphone or headphones are plugged in.•The volume is turned down completely. |
| Sound comes from the speaker even when the earphone or headphones are plugged in. | <ul style="list-style-type: none">•If you plug in the earphone or headphones not securely during playback, the sound may come from the speaker. Unplug the earphone or headphones and then insert it securely.•With some types of headphones, sound may come from both the speaker and headphones. Please use the headphones recommended for the IC recorder. |
| The OPR indicator does not light. | <ul style="list-style-type: none">•LED is set to OFF. Display the menu and set the LED to ON. |
| "FULL" is displayed and you cannot start recording. | <ul style="list-style-type: none">•The memory is full. Erase some of the messages (page 34).•99 messages have been recorded in the selected file. Select another file or erase some of the messages (page 34). |

| Symptom | Remedy |
|--|---|
| You cannot erase a message. | <ul style="list-style-type: none"> •The message or the folder which contains the message is set to "Read-only" in the computer. Display the message using Windows Explorer and remove the check for "Read-only" under "Properties". |
| You cannot add a recording or an overwrite recording. | <ul style="list-style-type: none"> •The remaining memory is too short. The overwritten part will be deleted after the overwriting part finishes recording. Therefore, you can only overwrite within the remaining recording time. •You cannot add a recording or an overwrite recording to an MSV (ADPCM) file recorded with the IC recorder ICD-MS1. |
| Recording is interrupted. | <ul style="list-style-type: none"> •The advanced VOR function (page 14) is activated. Set the VOR to OFF. |
| Noise is heard. | <ul style="list-style-type: none"> •An object, such as your finger, etc., accidentally rubbed or scratched the unit during recording so that noise was recorded. •The unit was placed near an AC power source, a fluorescent lamp or a mobile phone during recording or playback. •Plug of the connected microphone was dirty when recording. Clean the plug. •Earphone/headphones plug is dirty. Clean the plug. |
| Recording level is low. | <ul style="list-style-type: none"> •SENSE (microphone sensitivity) is set to L. Display the menu and set SENSE to H (page 53). |
| Recording level is unstable (when recording music, etc.). | <ul style="list-style-type: none"> •This unit is designed to automatically adjust the recording level when recording meetings, etc., and is not suitable for music recording. |
| Recording is interrupted (when recording from an external device). | <ul style="list-style-type: none"> •If you use a connecting cable without register to connect the sound source to the IC recorder, sound may be recorded interrupted. Make sure to use a registered connecting cable. |

Continued

Troubleshooting (continued)

| Symptom | Remedy |
|--|---|
| Playback speed is too fast or too slow. | • The playback speed is adjusted in DPC. Slide the DPC switch to OFF or display the menu and adjust the speed in DPC again (page 28). |
| "--:--" is displayed. | • You have not set the clock (page 8). |
| "--Y--M--D" or "--:--" is displayed on the REC DATE display. | • The date of recording will not be displayed if you recorded the message when the clock was not set. |
| You cannot erase the index. | • The bookmark is set for the message. Delete the bookmark, and then delete the index. |
| Messages are not sorted in order of the number of priority marks in a folder. | • Unless you sort messages using the supplied "Digital Voice Editor" software, messages are sorted in the unit the same as the setting in the computer. Sort again in the order of the number of priority marks in the computer using the supplied "Digital Voice Editor" software. |
| The remaining time displayed in the display window is shorter than that displayed in the supplied "Digital Voice Editor" software. | • The unit requires a certain amount of memory for system operation. That amount is subtracted from the remaining time, which is the reason for the difference. |
| The battery life is short. | • The battery life on page 7 is based on playback through internal speaker with the medium volume level (using Sony alkaline batteries LR03(SG)). The battery life may shorten depending on the operation of the unit. |
| The unit does not operate correctly. | • Take out the batteries and insert them again (page 6). |

Please note that recorded messages may be erased during service or repair work.

Error Messages of the IC Recorder

| Error message | Cause/Remedy |
|--------------------------------------|---|
| "BACK DATE" | <ul style="list-style-type: none">• You set the alarm when the time is already past. Check it and set the appropriate date and time. |
| "CANNOT" and "MOVE" flashes in turn. | <ul style="list-style-type: none">• You cannot use part of editorial features of this unit (adding a recording, overwriting a recording, adding/removing an index, setting a bookmark) for an MSV (ADPCM) file message recorded with the IC recorder ICD-MS1.• For some reason, you cannot move a message. |
| "ERR ACCESS" | <ul style="list-style-type: none">• The IC recorder failed in memory access. Remove and then insert the batteries. If this message appears again, you need to format the memory (page 50). Back up the data in the computer after checking the contents. |
| "ERR DATA" | <ul style="list-style-type: none">• The file is not supported by the "Digital Voice Editor" software, or the file itself is corrupted. |
| "ERR FORMAT" | <ul style="list-style-type: none">• The memory in the IC recorder is formatted with other device or the IC recorder failed in formatting the memory. Use the FORMAT in the menu to format the memory (page 50). |
| "FULL" | <ul style="list-style-type: none">• The remaining memory of the IC recorder is too small. Erase some messages before recording (page 34). |
| "ID FULL" | <ul style="list-style-type: none">• When there are already 99 messages in the selected folder or the remaining memory of the IC recorder is short, you cannot add an index. Erase some messages before adding an index (page 34). |
| "LOW BATT" | <ul style="list-style-type: none">• Batteries are weak. Replace batteries with new ones. |

Troubleshooting (continued)

| Error message | Cause/Remedy |
|---------------|---|
| "NO DATA" | •The selected folder does not have any messages. You cannot set the alarm, etc. because of this. |
| "NO ERASE" | •You cannot erase an index to combine messages of different modes. |
| "PRE SET" | •You set the alarm to play back a message at a date and time previously set on another message. Change the alarm setting. |
| "READ ONLY" | •Messages have been set to "Read-only" in the computer. You cannot edit or erase messages and folders including these "Read-only" messages. Remove the check for "Read-only" under "Properties" of files that are opened by Windows Explorer. |
| "SET DATE" | •If you do not set date and time, you cannot make alarm or time recording setting. To set date and time, see page 8. |

For the error messages of the "Digital Voice Editor", please refer to the online Help files.

If an error message with a number is displayed

If the following error display appears, please consult your nearest Sony dealer.

| Error number | Cause |
|--------------|--|
| "ERR 01" | The IC recorder cannot access the memory or cannot format the memory. |
| "ERR 02" | The IC recorder cannot write (record or erase) the data in the memory. |
| "ERR 03" | The IC recorder cannot read the memory. |
| "ERR 04" | The IC recorder cannot load or write the settings. |
| "ERR 05" | An error other than the above occurs. |

System Limitations

There are some system limitations of the unit. Troubles as mentioned below are not malfunctions of the unit.

| Symptom | Cause/Remedy |
|--|--|
| You cannot record messages up to the maximum recording time. | <ul style="list-style-type: none">• If you record messages in a mixture of SP and LP modes, the recordable time varies from the maximum SP mode recording time to the maximum LP mode recording time.• If there are a number of messages shorter than the minimum recording unit (Approx. 8 seconds in SP mode and approx. 22 seconds in LP mode), they are still counted as 8 seconds or 22 seconds, so the remaining recording time may decrease by more than the actual length of the messages.• Even when each message is longer than the minimum recording unit, if the length of each message cannot be divided by the minimum recording unit, the remaining recording time may decrease by more than the total length of the messages.• The sum of the number on the counter (elapsed recording time) and the remaining recording time may be less than the unit's maximum recording time. |
| You cannot add an index. | <ul style="list-style-type: none">• You cannot add an index in a folder which has 99 messages.• If you add or erase indexes frequently, the unit may become unable to add indexes. |
| You cannot erase the indexes. | <ul style="list-style-type: none">• You cannot erase an index to combine different recording mode (SP/LP) messages.• If you add or erase indexes frequently, the unit may become unable to erase indexes. |

Specifications

| | |
|--|--|
| Recording media | Built-in flash memory 64MB, Monaural recording |
| Recording time | SP: 532 minutes, LP: 1,418 minutes |
| Speaker | approx. 15 mm ($19/32$ in.) dia. |
| Power output | 80 mW |
| Input/Output | <ul style="list-style-type: none">• EAR/MIC (Earphone/microphone) jack (minijack, monaural)<ul style="list-style-type: none">– output for 16 - 100 ohms earphone/headphones– input for plug in power, minimum input level 0.6 mV, 3 kilohms or lower impedance microphone• USB connector |
| Playback speed control | +100% to -50% (DPC) |
| Power requirements | Two LR03 (size AAA) alkaline batteries: 3 V DC |
| Dimensions (w/h/d) (not incl. projecting parts and controls) | 28.0 × 116.0 × 13.8 mm ($1\ 1/8 \times 4\ 5/8 \times 9/16$ in.) |
| Mass (incl. batteries) | 65 g (2.29 oz) |
| Supplied accessories | Earphone × 1 USB Connecting cable × 1 Application Software (CD-ROM) × 1 Handstrap × 1 |
| Optional accessories | Stereo ear receiver MDR-ED228LP, MDR-E818LP/ Active speaker SRS-T77/Electret condenser microphone ECM-DM5P, ECM-T15, ECM-T115, ECM-Z60 (zoom microphone)/Connecting cable RK- G64/AC power adaptor AC-E30HG |

Your dealer may not handle some of the above listed optional accessories. Please ask the dealer for detailed information.



Design and specifications are subject to change without notice.

Index to Parts and Controls

Refer to the pages indicated in parentheses for details.

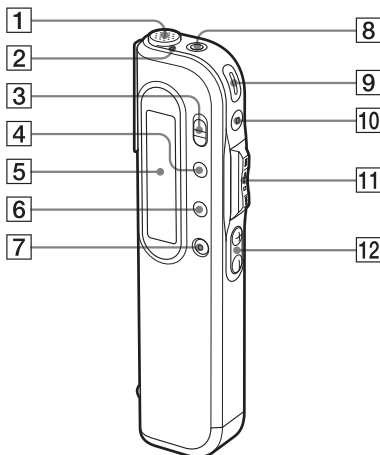
Front



- | | |
|---|--|
| 1 Built-in microphone (11) | 9 ●REC (record) /REC PAUSE button (11, 32) |
| 2 OPR (operation) indicator (11, 18) | 10 ■STOP button (12, 19) |
| 3 DPC ON/OFF switch (28) | 11 Jog lever FOLDER/MENU/ ◀◀ (review / fast backward) / ▶▶ (cue / fast forward) / ■•▶ (play / stop • enter) |
| 4 INDEX /  (bookmark) button (30, 37) | 12 VOL (volume) +/- buttons (18) |
| 5 Display window (22) | |
| 6 A-B  (repeat) / ★ (priority) button (31, 42) | |
| 7 ERASE button (34) | |
| 8 EAR/MIC (earphone / microphone) jack (13, 15) | |

Continued

Index to Parts and Controls (continued)

Rear

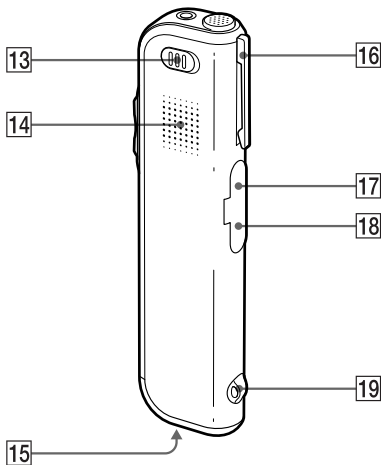

- 13** HOLD switch (27, 49)
- 14** Speaker
- 15** Battery compartment (6)
- 16** Clip*
- 17** USB connector (55)
- 18** DC IN 3V jack (6)
- 19** Slit for the supplied handstrap

*Notes

- To prevent the clip from breaking, avoid hooking it on thick fabric, such as a pocket of a heavy coat.
- When bending down or running with the unit clipped on your pocket, be careful not to drop the unit.

Index

- A**
A-B repeat 31
“ACCESS” message 7
Accidental operation 49
Add, bookmark 30
Add, index 38
Add, priority marks 42
Add, recording 32
Advanced VOR 14, 53
Alarm 44
- B**
Battery 6
Beep 54
Bookmark 30
Built-in microphone 11
- C**
Clock setting 8
Connecting, computer 55
Connecting, external
microphone 15
Connecting, other device 16
Continuous playback 20, 53
Counter display 26
Cue 20
- D**
Digital Voice Editor 55
Display mode 25
Display window 22
DPC
(Digital Pitch Control) .. 19, 28, 53
- E**
Easy search 20, 54
Erase, bookmark 30
Erase, index 39
Erase, messages 34
Error messages 61
Error numbers 62
External microphone 15
- F**
Folder 11, 17
Formatting the memory 50
- H**
Hold 27, 49
- I**
Index 37
- L**
LED 48
LP mode 7, 10, 54

Index (continued)

M

| | |
|------------------------------|--------------------|
| Maximum recording time | 10 |
| Menu | 29, 44, 48, 50, 52 |
| Message, adding | 32 |
| Message, erasing | 34 |
| Message, move | 41 |
| Message, playing back | 17, 18 |
| Message, recording | 10 |
| Message number | 11, 17 |
| Microphone, built-in | 11 |
| Microphone, connecting | 15 |
| Microphone, external | 15 |
| Microphone sensitivity | 13, 53 |
| Monitoring recording | 13 |
| Move | 41 |

O

| | |
|---------------------------|----|
| Overwrite recording | 33 |
|---------------------------|----|

P

| | |
|---------------------------------|------------|
| Playback | 18 |
| Playback pause function | 19 |
| Playback speed | 19, 28, 53 |
| Playing back continuously | 21 |
| Plug in power | 15 |
| Priority marks | 42 |

R

| | |
|----------------------------------|-----------|
| Recorded date/time display | 26 |
| Recording mode | 7, 10, 54 |
| Recording pause function | 12 |
| Remaining battery | 7 |
| Remaining display | 26 |
| Remaining memory | 14 |
| Repeat play | 21, 31 |
| Review | 13, 20 |

S

| | |
|-------------------------------|-----------|
| Search forward/backward | 20 |
| SP mode | 7, 10, 54 |
| System limitations | 63 |
| System requirements | 56 |

T

| | |
|---------------------------------|----|
| Turning off the display | 27 |
| Turning off the indicator | 48 |

U

| | |
|-----------------|----|
| USB cable | 55 |
|-----------------|----|

V

| | |
|----------------------|--------|
| Volume control | 18 |
| VOR | 14, 53 |

Printed on 100% recycled paper using VOC (Volatile Organic Compound)-free vegetable oil based ink.

<http://www.sony.net/>