

SONY®

2-698-600-11(2)

Portable Stereo Transmitter

Operating Instructions



TMR-BT10

©2006 Sony Corporation

WARNING

To reduce the risk of fire or electric shock, do not expose this apparatus to rain or moisture.

To reduce the risk of electrical shock, do not open the cabinet. Refer servicing to qualified personnel only.

Do not install the appliance in a confined space, such as a bookcase or built-in cabinet.

To reduce the risk of fire, do not cover the ventilation of the apparatus with newspapers, tablecloths, curtains, etc. And do not place lighted candles on the apparatus.

To reduce the risk of fire or electric shock, do not place objects filled with liquids, such as vases, on the apparatus.

Connect the AC power adaptor to an easily accessible AC outlet. Should you notice an abnormality in the AC power adaptor, disconnect it from the AC outlet immediately.



Hereby, Sony Corp., declares that this equipment is in compliance with the essential requirements and other relevant provisions of Directive 1999/5/EC. For details, please access the following URL :
<http://www.compliance.sony.de/>



Disposal of Old Electrical & Electronic Equipment (Applicable in the European Union and other European countries with separate collection systems)

This symbol on the product or on its packaging indicates that this product shall not be treated as household waste. Instead it shall be handed over to the applicable collection point for the recycling of electrical and electronic equipment. By ensuring this product is disposed of correctly, you will help prevent potential negative consequences for the environment and human health, which could otherwise be caused by inappropriate waste handling of this product. The recycling of materials will help to conserve natural resources. For more detailed information about recycling of this product, please contact your local Civic Office, your household waste disposal service or the shop where you purchased the product.

The Bluetooth word mark and logos are owned by the Bluetooth SIG, Inc. and any use of such marks by Sony Corporation is under license.

Other trademarks and trade names are those of their respective owners.

Table Of Contents

Welcome!	4
3 steps to BLUETOOTH function	5
Location and Function of Parts	6
Charging the unit	7
Pairing	9
What is pairing?	9
Procedures of pairing	9
Indications of BLUETOOTH function ..	11
Listening to music	12
Disposing of the unit	14
Precautions	15
What is BLUETOOTH technology?	17
Troubleshooting	18
Initializing the unit	20
Specifications	21

Welcome!

Thank you for purchasing this Sony Portable Stereo Transmitter. This unit uses BLUETOOTH™ wireless technology.

This unit can transmit stereo audio signal to a BLUETOOTH stereo audio receiving device (headset, car audio unit, stereo component system, etc.) *. By converting a regular stereo audio signal input (analogue) from the connected stereo audio source device to digital stereo audio signal and transmitting it wirelessly, you can enjoy listening to the music of your stereo audio source device connected to this unit (portable audio player, mobile phone, computer, etc.).

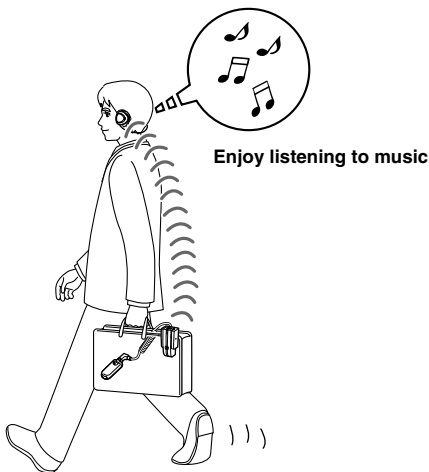

* BLUETOOTH devices to be connected with this unit are required to support A2DP (Advanced Audio Distribution Profile).

3 steps to BLUETOOTH function

In the example below, we explain how to transmit music played on your audio device connected to this unit and listen to music on a BLUETOOTH stereo audio receiving device (headphone, stereo audio system, etc.).

Pairing

Enables a BLUETOOTH stereo audio receiving device and this unit to recognize one another.

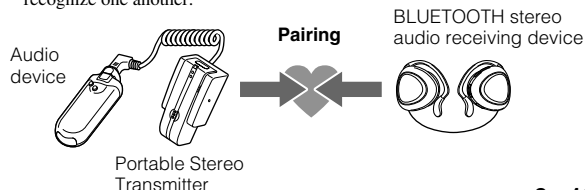

BLUETOOTH connection

Turning on this unit automatically makes the BLUETOOTH connection between this unit and the BLUETOOTH stereo audio receiving device.

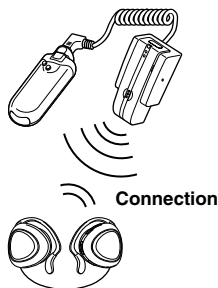

Transmitting music

You can enjoy listening to music played on the portable audio player, etc., connected to this unit through the BLUETOOTH audio receiving system.

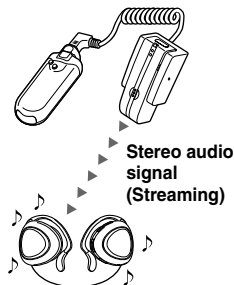

For more details, see page 12 - 13. **5**

Location and Function of Parts

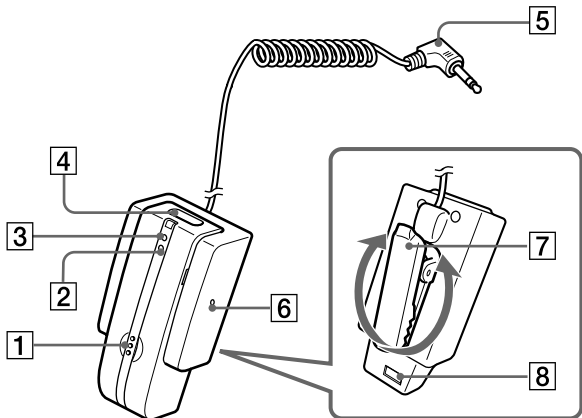

1 Initialize button

2 Indicator (red)

Indicates the power status of the unit.

3 Indicator (blue)

Indicates the communication status of the unit.

4 POWER button

5 Audio in plug (Gold-plated L-shaped stereo mini plug)

Connects to the headphone jack of a portable audio player, etc.

6 RESET button

7 Holding clip

Adjust the holding clip to the desired angle and clip to your bag.

8 Contact point

Charging the unit

The unit contains a rechargeable Lithium-Ion battery, which should be charged before using for the first time.

1 Connect the supplied AC power adaptor with the battery charging stand.

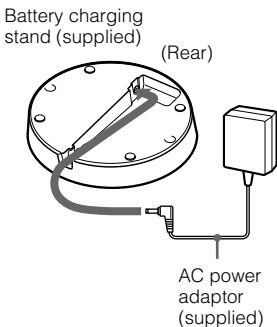

2 Connect the supplied AC power adaptor to an AC outlet.

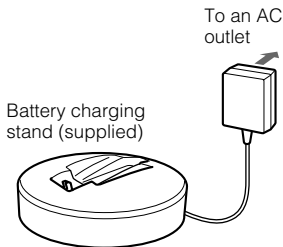

3 Put the unit on the battery charging stand.

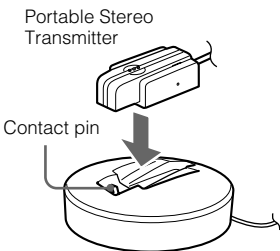

Note

If the holding clip is turned, the unit cannot be set on the battery charging stand and charging does not start. Turn the holding clip back to the original position before charging.

Rest the unit on the battery charging stand so that the unit's contact point meets the contact pin on the battery charging stand, and make sure that the indicator (red) lights up.

Charging is completed in about 3 hours* and the indicator (red) goes off automatically.

* Time required for empty battery to recharge.

Tip

When charging the battery, the unit is turned off automatically.

Continued 7

Caution

If this unit detects a problem while charging, the indicator (red) may turn off, although charging is not complete.

Check for the following causes:

- Ambient temperature exceeds the range of 0 °C – 40 °C (32 °F – 104 °F).
- There is a problem with the battery.

In this case, charge again within the above-mentioned temperature range. If the problem persists, consult your nearest Sony dealer.

Notes

- If the battery is not used for a long time, battery may be quickly depleted, however, after a few recharges, battery life will improve.
- If the life of the built-in rechargeable battery drops to half the normal length, the battery should be replaced. Consult your nearest Sony dealer for replacement of the rechargeable battery.
- Avoid exposure to temperature extremes, direct sunlight, moisture, sand, dust or mechanical shock. Never leave in a car parked in the sun.
- Use only the supplied AC power adaptor. Do not use any other AC power adaptor.

Usage hours*

Status	Approx. usage hours
Music playback time (up to)	11 hours

* Time stated above may vary, depending on ambient temperature or conditions of use.

Checking the remaining battery

When pressing the POWER button while the unit is turned on, the indicator (red) flashes. You can check the remaining battery by the number of times the indicator (red) flashes.

Indicator (red)	Status
3 times	Full
2 times	Mid
1 time	Low (needs to charge)

Note

You cannot check the remaining battery immediately after the unit is turned on, or while pairing.

When the battery is almost empty

The indicator (red) flashes slowly automatically.

When the battery becomes empty, the unit will turn off automatically.

Pairing

What is pairing?

BLUETOOTH devices need to be “paired” with each other beforehand. Once BLUETOOTH devices are paired, there is no need for pairing again, except in the following cases:

- When pairing information is deleted after repair, etc.
- When this unit is paired with 9 or more devices.

This unit can be paired with 8 BLUETOOTH devices; if a new device is paired after 8 devices have been paired, the device whose latest connection time is the oldest among the 8 paired devices is replaced by the new one.

- When recognition of the unit by the device to be connected is deleted.
- When this unit is initialized. All pairing information is deleted.

Note

Passcode* of this unit is fixed at “0000.”

This unit cannot be paired with a BLUETOOTH receiving device whose Passcode is not “0000.”

* Passcode may be called “Passkey,” “PIN code,” “PIN number,” or “Password.”

Procedures of pairing

- 1 Place a BLUETOOTH receiving device within 1 m (3 ft) of this unit.**
- 2 Press and hold the POWER button for 7 seconds or more to standby for pairing while the unit is turned off.**

The indicator (blue) and the indicator (red) start flashing together and this unit starts searching the BLUETOOTH receiving device.



Notes

- After about 3 seconds, power is turned on and the indicator (blue) and indicator (red) flash together twice. Keep the button pressed without releasing until both indicators start flashing together, then release the button. This unit enters into pairing mode.
- If pairing is not established within about 5 minutes, pairing mode will be cancelled and this unit will turn off. In this case, start over from step 1.

3 Set the BLUETOOTH receiving device to pairing mode.

This unit searches the BLUETOOTH receiving device automatically, and pairs the device.

The unit tries to connect the BLUETOOTH receiving device soon after detecting it. When the BLUETOOTH connection is made properly, the indicator (red) goes off and the indicator (blue) starts flashing more slowly, indicating pairing is complete and pairing information is memorized on this unit.

Notes

- If Passcode input is required on the BLUETOOTH receiving device, input "0000."
- The message standing for "Pairing complete" appears on the display of some BLUETOOTH receiving devices.
- When pairing is complete, some BLUETOOTH devices may connect with the unit automatically.

Tips

- To pair with other BLUETOOTH devices, repeat steps **1** to **3** for each device.
- To delete all pairing information, see "Initializing the unit" (page 20).

Indications of BLUETOOTH function

B : Indicator (blue)

R : Indicator (red)

Status		Flashing patterns	
Pairing		B	● - ● - ● - ● - ● - ● - ● - ● - ...
		R	● - ● - ● - ● - ● - ● - ● - ● - ...
Connecting		B	● - - ● - - ● - - ● - - ● - - ...
		R	-
Connected	Listening	B	●● - - - - - ●● - - - - ...
		R	-
	With no music	B	● - - - - - ● - - - - ...
		R	-

Listening to music

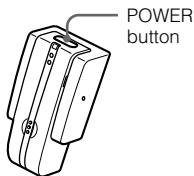

Check the following before operating the unit.

- Pairing of this unit and the BLUETOOTH receiving device is complete.
- The BLUETOOTH receiving device is on standby for connection.
- The BLUETOOTH receiving device supports the receiving music function (profile: A2DP).

1 Connect the stereo mini plug of this unit to the headphone jack of a stereo audio source device.

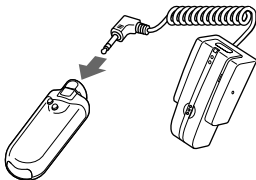

Note

When connecting to a stereo audio source device, be sure to connect this unit to the headphone jack, not to the LINE OUT jack.

2 Turn on the stereo audio source device.

3 Press and hold the POWER button for about 3 seconds while the unit is turned off.

The indicator (blue) and indicator (red) flash together twice, then the unit is turned on. After the unit is turned on, it connects to the BLUETOOTH receiving device automatically.

Notes

- Do not press and hold the POWER button for more than 7 seconds, otherwise pairing mode is entered.
- Make sure to turn on only the BLUETOOTH receiving device you want to connect with this unit. If many BLUETOOTH receiving devices are turned on, the connection may not be done as you desire.
- If this unit cannot make the BLUETOOTH connection with a paired device, pair the device again, or try making the BLUETOOTH connection from the BLUETOOTH receiving device if possible.

Tips

- While searching a BLUETOOTH receiving device, the indicator (blue) keeps flashing.
- If two or more devices are paired with this unit, this unit tries to connect with either of the last two devices recognized before.

- BLUETOOTH connection of this unit is established with A2DP (Advanced Audio Distribution Profile)*
- For details on how to operate the BLUETOOTH receiving device, refer to the operating instructions supplied with the device.
- * For details on profiles, see page 17.

4 Start playing on the stereo audio source device connected to this unit.

Notes

- If sound is distorted, turn down the volume of the connected device.
- If volume is low or noise occurs, turn up the volume of the connected device.
- Turn off the bass boost function or equalizer function. If these functions are on, sound may be distorted.

Tips

- Turn up the volume of the stereo audio source device as high as possible to the extent that sound is not distorted, then adjust the volume on the BLUETOOTH receiving device to a moderate level.
- If this unit is in your bag, the BLUETOOTH connection may decline. Clip this unit on the bag.

Notes

- Even if the BLUETOOTH receiving device supports AVRCP (Audio Video Remote Control Profile), this unit cannot perform playback control functions.
- In the following cases, you need to make the BLUETOOTH connection again.
 - The power of this unit does not turn on.
 - The power of the BLUETOOTH stereo audio receiving device does not turn on, or the BLUETOOTH function is off.
 - The BLUETOOTH function of this unit or the BLUETOOTH stereo audio receiving device is in sleep mode.
 - The BLUETOOTH connection is not made.

To stop use

1 Turn off the BLUETOOTH receiving device.

2 Press and hold the POWER button on this unit for about 3 seconds.

The indicator (blue) and indicator (red) light up together, and the unit turns off.

Tip

When you finish playing music, the BLUETOOTH connection may terminate automatically, depending on the BLUETOOTH device.

Disposing of the unit

For environmental conservation, be sure to remove the built-in rechargeable battery from the unit before disposing, and dispose of the battery appropriately.

1 Remove 2 screws.

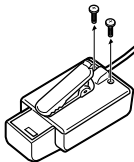

3 Remove the rechargeable battery and dispose of it.

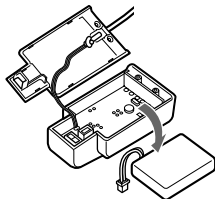

2 Open the case and detach the connector.

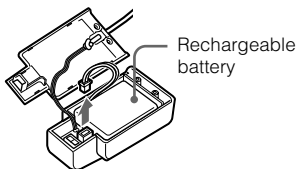

Precautions

On BLUETOOTH communication

- BLUETOOTH wireless technology operates within a range of about 10 m (about 30 ft). Maximum communication range may vary depending on obstacles (person, metal, wall, etc.) or electromagnetic environment.
- The following conditions may affect the sensitivity of BLUETOOTH communication.
 - There is an obstacle such as a person, metal, or wall between this unit and BLUETOOTH device.
 - A device using 2.4 GHz frequency, such as a wireless LAN device, cordless telephone, or microwave oven, is in use near this unit.
- Because BLUETOOTH devices and wireless LAN (IEEE802.11b/g) use the same frequency, microwave interference may occur and resulting in communication speed deterioration, noise, or invalid connection if this unit is used near a wireless LAN device. In such a case, perform the following.
 - Use this unit at least 10 m (about 30 ft) away from the wireless LAN device.
 - If this unit is used within 10 m (about 30 ft) of a wireless LAN device, turn off the wireless LAN device.
 - Install this unit and BLUETOOTH device as near to each other as possible.
- Microwaves emitting from a BLUETOOTH device may affect the operation of electronic medical devices. Turn off this unit and other BLUETOOTH devices in the following locations, as it may cause an accident.
 - where inflammable gas is present, in a hospital, train, airplane, or a petrol station
 - near automatic doors or a fire alarm
- This unit supports security capabilities that comply with the BLUETOOTH standard to provide a secure connection when the BLUETOOTH wireless technology is used, but security may not be enough depending on the setting. Be careful when communicating using BLUETOOTH wireless technology.
- We do not take any responsibility for the leakage of information during BLUETOOTH communication.
- Connection with all BLUETOOTH devices cannot be guaranteed.
 - A device featuring BLUETOOTH function is required to conform to the BLUETOOTH standard specified by BLUETOOTH SIG, and be authenticated.
 - Even if the connected device conforms to the above mentioned BLUETOOTH standard, some devices may not be connected or work correctly, depending on the features or specifications of the device.
- Depending on the device to be connected, it may require some time to start communication.

Notes on using in a car

- Do not attempt to connect this unit, or to operate this unit, an audio output device or a car radio while driving or waiting at a traffic signal.
- Make sure this unit and the device connected to this unit are fixed firmly before driving to avoid an accident or damage.
- Route all the cable connected to this unit properly so that they will not interfere with your driving or become entangled in parts of the car interior (seat, door, etc.).

On the supplied AC power adaptor

- Use the AC power adaptor supplied with this unit. Do not use any other AC power adaptor since it may cause the unit to malfunction.



Polarity of the plug

- If you are not going to use this unit for a long time, unplug the AC power adaptor from the AC outlet. To remove the AC power adaptor from the wall outlet, grasp the adaptor plug itself; never pull the cord.

Others

- Do not place the unit in any of the following locations.
 - Direct sunlight, near a heater, or other extremely high-temperature location
 - Dusty location
 - Location exposed to large amounts of vibration
 - Bathroom or other high-humidity location
 - In a car subject to the direct rays of the sun.

- Do not drop, hit, or otherwise expose the unit to strong shock of any kind. This could damage the product.
- Using the BLUETOOTH device may not function on mobile phones, depending on radio wave conditions and location where the equipment is being used.
- If you experience discomfort after using the BLUETOOTH device, stop using the BLUETOOTH device immediately. Should any problem persist, consult your nearest Sony dealer.
- Do not allow small children to use this unit.
- If you have any questions or problems concerning this unit that are not covered in this manual, please consult your nearest Sony dealer.

What is BLUETOOTH technology?

BLUETOOTH wireless technology is a short-range wireless technology that enables wireless data communication between digital devices, such as a computer or digital camera. BLUETOOTH wireless technology operates within a range of about 10 m (about 30 ft). Connecting two devices as necessary is common, but some devices can be connected to multiple devices at the same time.* You do not need to use a cable for connection since BLUETOOTH technology is a wireless technology, nor is it necessary for the devices to face one another, such is the case with infrared technology. For example, you can use such a device in a bag or pocket. BLUETOOTH technology is an international standard supported by millions of companies all over the world, and employed by various companies worldwide.

* This unit cannot be connected to multiple devices at the same time.

Communication System and Compatible BLUETOOTH Profiles of this unit

Profile is standardization of the function for each BLUETOOTH device specification. This unit supports the following BLUETOOTH version and profile:

Communication System: BLUETOOTH Specification version 2.0

Compatible BLUETOOTH Profile:

- A2DP (Advanced Audio Distribution Profile)

Troubleshooting

If you run into any problems using this unit, use the following checklist. Should any problem persist, consult your nearest Sony dealer.

Common

The unit is not turned on.

- ➔ Charge the battery of the unit.
- ➔ The unit is not turned on while charging. Remove the unit from the battery charging stand and then turn on the unit.

Sound skips or the correspondence distance is short.

- ➔ If a device that generates electromagnetic radiation, such as a wireless LAN, other BLUETOOTH device(s), or a microwave oven is nearby, move away from such sources.
- ➔ Remove any obstacle between this unit and other BLUETOOTH device or move away from the obstacle.
- ➔ Locate this unit and other BLUETOOTH device(s) as near as possible.
- ➔ Re-position this unit.

Pairing cannot be done.

- ➔ Bring this unit and the BLUETOOTH device closer together.

Cannot make the BLUETOOTH connection.

- ➔ Check that this unit is turned on.
- ➔ Check that the BLUETOOTH connecting device is turned on and the BLUETOOTH function is on.
- ➔ Connection with the BLUETOOTH device may not be memorized on this unit. Make the BLUETOOTH connection from the BLUETOOTH device to this unit soon after pairing is complete.
- ➔ This unit or BLUETOOTH connecting device is in sleep mode.
- ➔ The BLUETOOTH connection is terminated. Make the BLUETOOTH connection again.

Cannot operate the unit. (Connection has hung up.)

- ➔ Press the RESET button. Pairing information is not deleted by this operation.

When listening to music

No sound

- ➔ Check the connection between this unit and the stereo audio source device connected to this unit.
- ➔ Check that both this unit and the BLUETOOTH stereo audio receiving device are turned on.
- ➔ Ensure that this unit is not too far from the BLUETOOTH stereo audio receiving device, or this unit is not receiving interference from a wireless LAN, other 2.4 GHz wireless device, or microwave oven.
- ➔ Check that BLUETOOTH connection is made properly between this unit and the BLUETOOTH stereo audio receiving device.
- ➔ Turn up the volume of the BLUETOOTH stereo audio receiving device. For details on volume adjustment, refer to the operating instructions supplied with the BLUETOOTH stereo audio receiving device.
- ➔ Turn up the volume of the stereo audio source device as high as possible to the extent that sound is not distorted.
- ➔ Pair this unit and the BLUETOOTH stereo audio receiving device again.

Low sound level

- ➔ Turn up the volume of the stereo audio source device as high as possible to the extent that sound is not distorted.
- ➔ Turn up the volume of the BLUETOOTH stereo audio receiving device. For details on volume adjustment, refer to the operating instructions supplied with the BLUETOOTH stereo audio receiving device.

- ➔ Connect the audio in plug to the headphone jack instead of the LINE OUT jack.

Distorted sound

- ➔ Turn down the volume of the stereo audio source device to the point where the sound is no longer distorted. For details on volume adjustment, refer to the operating instructions supplied with the stereo audio source device.
- ➔ Connect the audio in plug to the headphone jack instead of the LINE OUT jack.

Cannot be connected to a device that has been paired and connected before.

- ➔ This unit tries to connect with either of the last two devices recognized before. If this unit cannot make the BLUETOOTH connection with a paired device, pair the device again, or try making the BLUETOOTH connection from the BLUETOOTH stereo audio receiving device if possible.
- ➔ Pairing information may be deleted. Pair the device again.

Initializing the unit

You can reset this unit to its default (such as volume setting) and delete all pairing information.

- 1 If this unit is turned on, press and hold the POWER button for about 3 seconds to turn off this unit.**
- 2 Press and hold the POWER button and the initialize button together for about 7 seconds.**

The indicator (blue) and indicator (red) flash together four times, and this unit is reset to the default setting. All pairing information is deleted.

Specifications

General

Communication system

BLUETOOTH Specification version 2.0

Output

BLUETOOTH Specification Power Class 2

Frequency band

2.4 GHz band (2.4000 GHz – 2.4835 GHz)

Maximum communication range

Line of sight approx. 10 m (30 ft)*¹

Modulation method

FHSS

Compatible BLUETOOTH Profile*²

A2DP (Advanced Audio Distribution Profile)

Supported codec*³

SBC*⁴

Audio input

Gold-plated L-shaped stereo mini plug × 1

Input impedance

Approx. 32 Ω

Power source

DC 3.7 V: Built-in lithium-ion rechargeable battery

Rated power consumption

1.5 W

Dimensions

Approx. 25 × 51 × 29 mm
(1 × 2 × 1 ³/₁₆ in) (w/h/d)

Mass

Approx. 27 g (1.0 oz) (including cord)

Supplied accessories

AC power adaptor (1)

Battery charging stand (1)

Design and specifications are subject to change without notice.

*¹ The actual range will vary depending on factors such as obstacles between devices, magnetic fields around a microwave oven, static electricity, reception sensitivity, aerial's performance, operating system, software application, etc.

*² BLUETOOTH standard profiles indicate the purpose of BLUETOOTH communication between devices.

*³ Codec: Audio signal compression and conversion format

*⁴ Subband Codec

<http://www.sony.net/>

Printed in Malaysia



* 2 6 9 8 6 0 0 1 1 * (2)